



**FOURIERS**

High Performance Bike Components



**FOURIERS**

MV-10000-100



# Index

E1	8
ROAD BIKE HANDLEBARS	12
MTB HANDLEBARS	14
STEM	19
SEATPOST	28
BB SYSTEM	31
ROAD BRAKE	32
V-BRAKE	35
DISC ROTOR	36
BRAKE PADS	38
LEVER	39
QUICK RELEASE	40
CHAIN GUIDE	44
BASH GUARD	47
ACCESSORIES	48

---

TRIATHLON	50
CYCLO CROSS	54
FIXED GEAR	57

---

CLAMP	61
SPACER	66
HEADSET	68
HEAD ACCESSORIES	69
TOP CAP	70
ACCESSORIES	73
BOLT	75
VALVE EXTENDER	76
VALVE CAP	77
TOOL	79
PROTECTOR	80







## ***ABOUT US***

We are a group of bike riders and a family firm of engineers. We have more than 20 years of experience on the CNC machine works and enriched our knowledge of the material, we choice what is most strong, light and stable material for the Bike Parts. Most of our products are made of strong alloy, carbon and the worldwide well-known plastic raw materials from Swiss.

All of our products are made in Taiwan, that's because we know the quality issue is the most important for all customers, because of our great passion on the bike products, we just have a desire to be a world-class supplier, to develop and fabricate the best bicycle components.



# 35 SYSTEM

Why 35mm? We get this question asked to us a lot about our handlebars and stems. We believe in the 35 system because after repeated testing and analysis on our test machines and in the real world, we found that the thicker bar is more stable than the presently 31.8 system. There are still some sceptics on this spec upgrade so we make it easy to be a convert. We make a carbon shim to retrofit

our stems which can change a 35mm stem to fit a 31.8mm bar. Along with the added strength of using an oversized stem, we found through our vibration testing machine that the carbon shim significantly reduces riding vibrations due to the natural riding properties of carbon.



HB-MB009

# E1

E1 is our entry level platform. It has all of Fouriers high quality standards with excellent rigidity and is suitable for a wide variety of riding styles.

HB-MB011



SP-E001



SM-RA004

## SP-E001

Economic, strong, and good looking alloy seat post. Double screw locking for head angle adjustment.

### Product Features:

- Material: Alloy 6061-T6 body  
Alloy 6066-T6 tube  
Alloy 6061-T6 saddle clamp
- Spec: Ø27.2, Ø31.6
- Length: 300 / 350 / 400mm
- Offset: 20mm
- Color: Sandblast black anodized
- Weight: 310g (Ø31.6 350mm)

## SM-RA004

AL6061-T6 3D forged body.

### Product Features:

- Material: AL6061-T6 3D forged
- Bar-bore Ø31.8; Steerer tube Ø28.6
- Fork stack height 41.8mm
- Angle : ±8°
- Length: 70~130mm
- Weight: 145g~168g





### HB-MB009

Mountain bike XC alloy handlebar, double butted construction to reduce the weight while keeping the strength.

Product Features:

- Material: AL6061-T6
- Bar-bore: Ø31.8mm
- Width: 580mm, 680mm
- Back sweep: 5 degree
- Weight: 160g~210g
- Color: Sandblast anodize

### HB-MB011

Mountain bike XC riser alloy handlebar, double butted construction to reduce the weight while keeping the strength.

Product Features:

- Material: AL6061-T6
- Bar-bore: Ø31.8mm
- Width: 640mm, 780mm
- Back sweep: 9 degree
- Up sweep: 5 degree
- Rise: 20mm/30mm/40mm
- Weight: 275g~375g
- Color: Sandblast anodize



## ***Fatigue Testing Machine***

In order to strengthen the safety of the riders, we use the standard of "CEN" to test our products. A lightweight and safe riding experience for the riders to enjoy their ride is our goal to satisfy the customers' demand.

---

## ***Inspection Machine***

To assure the safety of carbon-fiber-made products, all of our every product needs to pass the test from the Inspection Machine and then to the Microcomputer Attenuation Tester for a further inspection.

---

## ***EFBE, Testing Center in Germany***

After EN testing at Cycling & Health Industry R&D Center (in Taiwan), we send our products for further inspections at EFBE in Germany to reach the international standard and ensure our expectation of a high standard request.

**EFBE**  
PRÜFTECHNIK

# ROAD BIKE HANDLEBARS

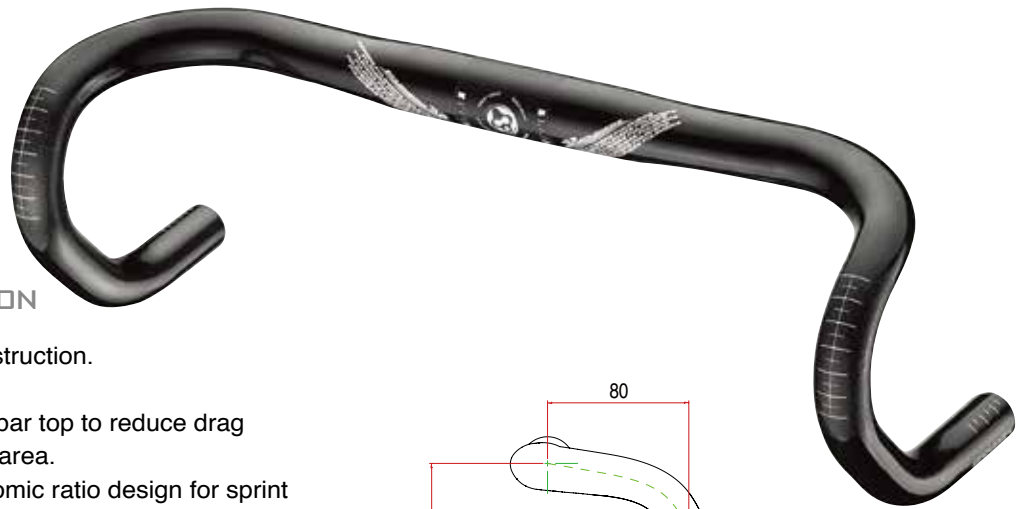

## HB-RA001 CARBON

One piece monocoque construction.  
Passed safety test.  
Fluid mechanics design on bar top to reduce drag increases the hand contact area.  
Lower bar area to use anatomic ratio design for sprint position.

### Product Features:

- Material: Carbon fiber
- Spec: 31.8mm x W400, 420, 440mm (c-c)
- Drop: 130mm
- Reach: 80mm
- Bar type: anatomic-bend
- Weight: 216g (W420mm)
- Pass EFBE test

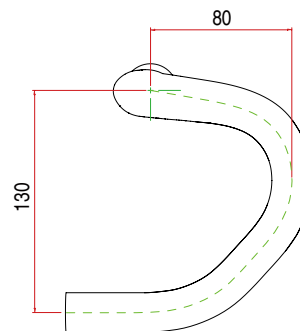

ANATOMIC-BEND

**EFBE**

PRÜFTECHNIK

P1206089 / P1206090  
P1206091

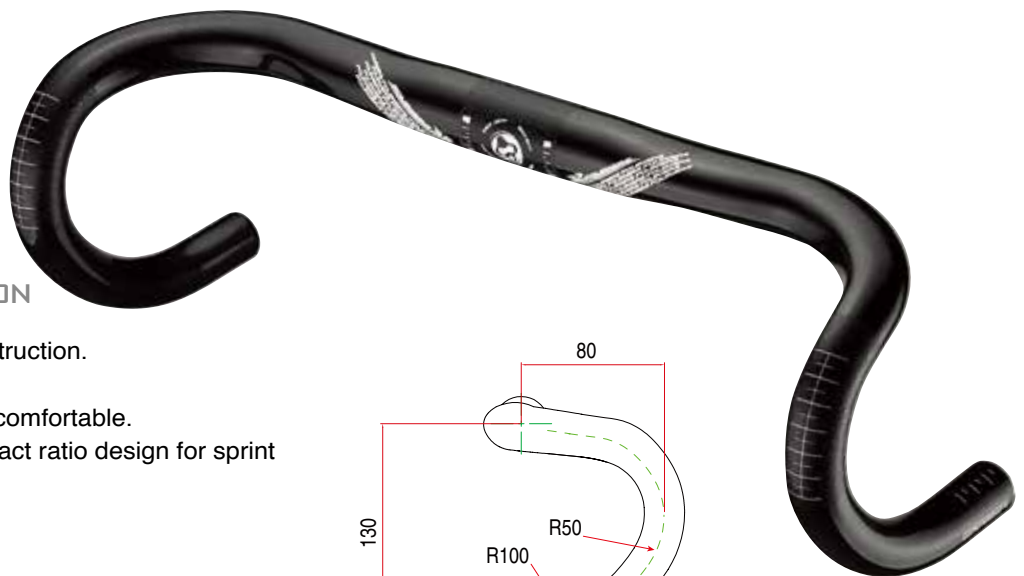

## HB-RA002 CARBON

One piece monocoque construction.  
Passed safety test.  
Ergonomic design for more comfortable.  
Lower bar area to use compact ratio design for sprint position.

### Product Features:

- Material: Carbon fiber
- Spec: 31.8mm x W400, 420, 440mm (c-c)
- Drop: 130mm
- Reach: 80mm
- Bar type: compact
- Weight: 216g (W420mm)
- Pass EFBE test

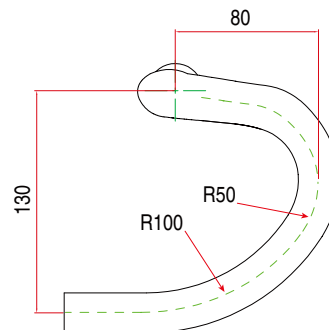

COMPACT

**EFBE**

PRÜFTECHNIK

P1206089 / P1206090  
P1206091





## HB-RA003



CARBON

Over-sized diameter on the bar bore to achieve better strength.

One piece monocoque construction.

Passed safety test.

Fluid mechanics design on bar top to reduce drag / increase the hand contact area.

Lower bar area to use compression ratio design for multiple hand-hold position.

### Product Features:

- Material: Carbon fiber
- Spec: 35mm x W400, 420, 440mm (c-c)
- Drop: 128mm
- Reach: 78mm
- Bar type: compact
- Weight: 225g (W420mm)
- Pass EFBE test

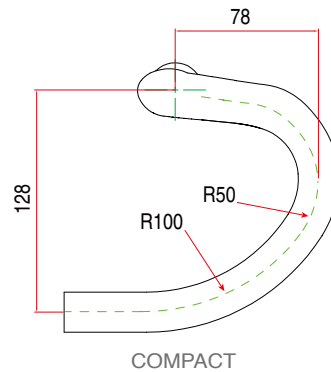

**EFBE**  
PRUFTECHNIK

P1206086 / P1206087  
P1206088

MODEL	PRIMARY USES	COLOR	WEIGHT	FEATURES
HB-RA001-400	ROAD BIKE	CARBON UD	216.0g	Bar-bore Ø31.8mm x W400mm (c-c) RISE: 130mm / REACH: 80mm / Bar type: Anatomic-bend
HB-RA001-420	ROAD BIKE	CARBON UD	220.0g	Bar-bore Ø31.8mm x W400mm (c-c) RISE: 130mm / REACH: 80mm / Bar type: Anatomic-bend
HB-RA001-440	ROAD BIKE	CARBON UD	225.0g	Bar-bore Ø31.8mm x W440mm (c-c) RISE: 130mm / REACH: 80mm / Bar type: Anatomic-bend
HB-RA002-400	ROAD BIKE	CARBON UD	216.0g	Bar-bore Ø31.8mm x W400mm (c-c) RISE: 130mm / REACH: 80mm / Bar type: Compact
HB-RA002-420	ROAD BIKE	CARBON UD	220.0g	Bar-bore Ø31.8mm x W420mm (c-c) RISE: 130mm / REACH: 80mm / Bar type: Compact
HB-RA002-440	ROAD BIKE	CARBON UD	225.0g	Bar-bore Ø31.8mm x W420mm (c-c) RISE: 130mm / REACH: 80mm / Bar type: Compact
HB-RA003-400	ROAD BIKE	CARBON UD	225.0g	Bar-bore Ø35mm x W400mm (c-c) RISE: 128mm / REACH: 78mm / Bar type: Compact
HB-RA003-420	ROAD BIKE	CARBON UD	230.0g	Bar-bore Ø35mm x W420mm (c-c) RISE: 128mm / REACH: 78mm / Bar type: Compact
HB-RA003-440	ROAD BIKE	CARBON UD	235.0g	Bar-bore Ø35mm x W440mm (c-c) RISE: 128mm / REACH: 78mm / Bar type: Compact

# MTB HANDLEBARS



**HB-MB001**  **CARBON**



**HB-MB002** **CARBON**

## **HB-MB001** **CARBON**

One piece monocoque construction.  
 Enlarge diameter at stem clamping area to get better strength.  
 Extra width can efficiently increase stability control.  
 Can adjust the width from 660-780mm.

### Product Features:

- Material: Carbon fiber
- Spec: 35mm x W780mm
- Rise: 20mm
- Back sweep: 9 degree
- Up sweep: 5 degree
- Weight: 279g
- Overload: 500kgs
- Pass EFBE test



P1306487 / P1306488 / P1306489

## **HB-MB002** **CARBON**

One piece monocoque construction.  
 Extra width can efficiently increase stability control.  
 Can adjust the width from 660-780mm.

### Product Features:

- Material: Carbon fiber
- Spec: 31.8mm x W780mm
- Rise: 20mm
- Back sweep: 9 degree
- Up sweep: 5 degree
- Weight: 273g
- Overload: 500kgs
- Pass EFBE test



P1306490 / P1306491 / P1306492

MODEL	PRIMARY USES	COLOR	WEIGHT	FEATURES
HB-MB001-350	MTB	CARBON UD	279.0g	Bar-bore Ø35mm x W780mm OFFSET: 20mm / Back Sweep: 9° / Up Sweep: 5°
HB-MB002-320	MTB	CARBON UD	273.0g	Bar-bore Ø31.8mm x W780mm OFFSET: 20mm / Back Sweep: 9° / Up Sweep: 5°



**HB-MB003**  ALLOY 6066

**HB-MB004** ALLOY 6066

**HB-MB003**  ALLOY 6066

Made of special material Alloy 6066 and double butted, stronger than Alloy 6061 and have anti-stress corrosion, better than 7000 series. Extra width can efficiently increase stability control. Can adjust the width from 660-780mm. Specially designed for freeride & downhill riding.

Product Features:

- Material: Alloy 6066-T6
- Spec: 35mm x W780mm
- Rise: 20mm
- Back sweep: 9 degree
- Up sweep: 5 degree
- Weight: 427.5g
- Overload: 500kgs
- Pass EFBE test
- Color option:

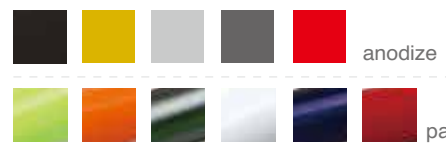

**HB-MB004** ALLOY 6066

Made of special material Alloy 6066 and double butted, stronger than Alloy 6061 and have anti-stress corrosion, better than 7000 series. Extra width can efficiently increase stability control. Can adjust the width from 660-780mm. Specially designed for freeride & downhill riding.

Product Features:

- Material: Alloy 6066-T6
- Spec: 31.8mm x W780mm
- Rise: 20mm
- Back sweep: 9 degree
- Up sweep: 5 degree
- Overload: 500kgs
- Weight: 382g
- Color option:

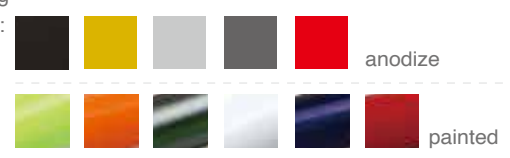

P1206028 / P1206029 / P1206030

MODEL	PRIMARY USES	COLOR	WEIGHT	FEATURES
HB-MB003	MTB	BLACK / SILVER / RED / GOLD / GRAY PAINTED NEON GREEN / PAINTED NEON ORANGE / PAINTED BLACK / PAINTED WHITE / PAINTED BLUE / PAINTED RED	427.5g	Bar-bore Ø35mm x W780mm Rise: 20mm / Back Sweep: 9° / Up Sweep: 5°
HB-MB004	MTB	BLACK / SILVER / RED / GOLD / GRAY PAINTED NEON GREEN / PAINTED NEON ORANGE / PAINTED BLACK / PAINTED WHITE / PAINTED BLUE / PAINTED RED	382.0g	Bar-bore Ø31.8mm x W780mm Rise: 20mm / Back Sweep: 9° / Up Sweep: 5°

# MTB HANDLEBARS



## HB-MB007 ALLOY 7050

Made of Alloy 7050-T73 double butted hydroformed material. Can increase strength and decrease the risk of stress corrosion.

**Eccentric design adjusts angle +/-5mm.**

### Product Features:

- Material: Alloy 7050-T73 double butted tube
- Spec: 31.8mm x W720mm
- **Eccentric: 5mm**
- Back sweep: 9 degree
- Weight: 235g



## HB-MB008 CARBON

The best 9 degree bend angle design to make you more comfortable on ride. Advanced material effectively absorb the uneven road surface vibrations. Eccentric design can change height of 5mm to reduce the height of handlebar. It's a great choice to shave weight off your bike.

**Eccentric design adjusts angle +/-5mm.**

### Product Features:

- Material: Carbon fiber
- Spec: Ø31.8mm x W750mm
- **Eccentric: 5mm**
- Back sweep: 9 degree
- Weight: 170g

MODEL	PRIMARY USES	COLOR	WEIGHT	FEATURES
HB-MB007	MTB	BLACK / SILVER RED	235.0g	Bar-bore Ø31.8mm x W720mm Offset 5mm / Back Sweep: 9°
HB-MB008	MTB	CARBON UD	170.0g	Bar-bore Ø31.8mm x W750mm Offset 5mm / Back Sweep: 9°





### HB-MB009 ALLOY 6061

Mountain bike XC alloy handlebar, double butted construction to reduce the weight while keeping the strength.

Product Features:

- Material: AL6061-T6
- Bar-bore: Ø31.8mm
- Width: 580mm, 680mm
- Back sweep: 5 degree
- Weight: 160g~210g
- Color: Sandblast anodize



### HB-MB010 ALLOY 7050

Mountain bike XC alloy handlebar, double butted construction to reduce the weight while keeping the strength.

Product Features:

- Material: AL7050-T73
- Bar-bore: Ø31.8mm
- Width: 580mm or 680mm
- Back sweep: 5 degree
- Weight: 160g~210g
- Color: Sandblast anodize



### HB-MB011 ALLOY 6061

Mountain bike XC riser alloy handlebar, double butted construction to reduce the weight while keeping the strength.

Product Features:

- Material: AL6061-T6
- Bar-bore: Ø31.8mm
- Width: 640mm, 780mm
- Back sweep: 9 degree
- Up sweep: 5 degree
- Rise: 20mm / 25mm / 30mm
- Weight: 275g~375g
- Color: Sandblast anodize



### HB-MB012 ALLOY 7050

Mountain bike XC riser alloy handlebar, double butted construction to reduce the weight while keeping the strength.

Product Features:

- Material: AL7050-T73
- Bar-bore: Ø31.8mm
- Width: 640mm, 780mm
- Back sweep: 9 degree
- Up sweep: 5 degree
- Rise: 20mm / 25mm / 30mm
- Weight: 275g~375g
- Color: Sandblast anodize

MODEL	PRIMARY USES	COLOR	WEIGHT	FEATURES
HB-MB009	MTB	BLACK / SILVER / RED	160g ~ 210g	Bar-bore Ø31.8mm / Width: 580mm or 680mm / Back sweep: 5°
HB-MB010	MTB	BLACK / SILVER / RED	160g ~ 210g	Bar-bore Ø31.8mm / Width: 580mm or 680mm / Back sweep: 5°
HB-MB011	MTB	BLACK / SILVER / RED	275g ~ 375g	Bar-bore Ø31.8mm / Width: 640mm or 780mm / Rise: 20, 25, 30mm / Back sweep: 9° / Up sweep: 5°
HB-MB012	MTB	BLACK / SILVER / RED	275g ~ 375g	Bar-bore Ø31.8mm / Width: 640mm or 780mm / Rise: 20, 25, 30mm / Back sweep: 9° / Up sweep: 5°

# CARBON SHIM



FRF (Frequency Response Function)  
Experimental Results:

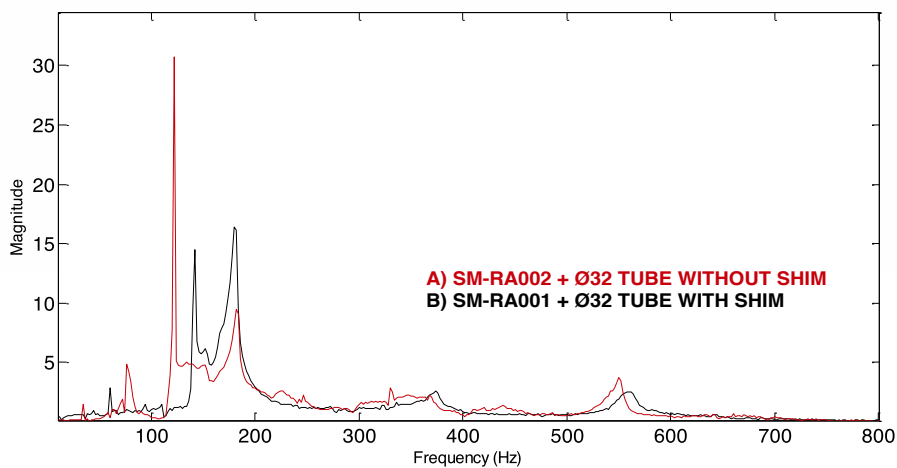

Results: The stem without a shim has a resonant peak as high as 31 in magnitude at 122 Hz. Whereas the stem with shim has a resonant peak of only 15 in magnitude at 140 Hz. The result indicates that the stem with a shim will have smaller vibration amplitudes.

Time Waveform Chart  
Experimental Results:

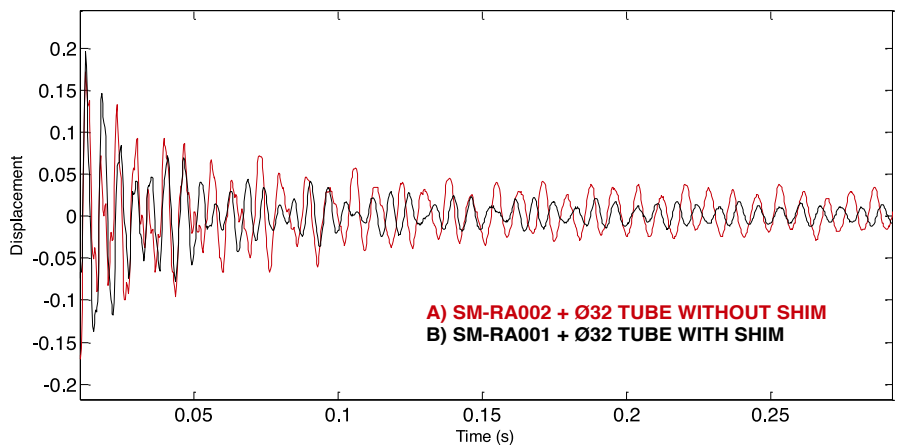

Results: Initially, the amplitudes of the waveforms of both stems are almost the same. However, the amplitude of the stem with a shim declines faster. After 0.05 seconds, the amplitude of the stem with a shim is smaller than that of the stem without shim.

## SM-RA001

Full CNC made, unique light weight.  
Alloy 6066 material effectively enhances the overall strength and improves hard to stress corrosion.

Bar bore size upgrade to Ø35mm conget adds stiffness with Ø35mm handlebar.

80-140mm length, 7 sizes to choose from.

Has been approved by EN test standards.



AC-S002



AC-S001

### Product Features:

- Material: Alloy 6066-T6
- Spec: 80~140mm
- Angle: ±8 degree
- Fork stack height: 40mm fork tube 31.8mm
- Handlebar clamp: 35mm
- With SHIM (AC-S001) - fork tube Ø31.8 change to Ø28.6
- SHIM (AC-S002) - handlebar clamp Ø35 change to Ø31.8
- Weight: 80mm/131g  
90mm/135g  
100mm/137g  
110mm/141.5g  
120mm/146g  
130mm/151g  
140mm/156g
- Pass EFBE test

## EFBE

PRÜFTECHNIK

P1306487 / P1306488  
P1306489



MODEL	PRIMARY USES	COLOR	WEIGHT	FEATURES
SM-RA001-801	ROAD / MTB	BLACK	131.0g/pcs	DEGREE: ±8° / LENGTH: 80mm For Fork 1-1/4" / Bar-bore 35mm / with carbon shim & top cap
SM-RA001-901	ROAD / MTB	BLACK	135.0g/pcs	DEGREE: ±8° / LENGTH: 90mm For Fork 1-1/4" / Bar-bore 35mm / with carbon shim & top cap
SM-RA001-1001	ROAD / MTB	BLACK	137.0g/pcs	DEGREE: ±8° / LENGTH: 100mm For Fork 1-1/4" / Bar-bore 35mm / with carbon shim & top cap
SM-RA001-1101	ROAD / MTB	BLACK	141.5g/pcs	DEGREE: ±8° / LENGTH: 110mm For Fork 1-1/4" / Bar-bore 35mm / with carbon shim & top cap
SM-RA001-1201	ROAD / MTB	BLACK	146.0g/pcs	DEGREE: ±8° / LENGTH: 120mm For Fork 1-1/4" / Bar-bore 35mm / with carbon shim & top cap
SM-RA001-1301	ROAD / MTB	BLACK	151.0g/pcs	DEGREE: ±8° / LENGTH: 130mm For Fork 1-1/4" / Bar-bore 35mm / with carbon shim & top cap
SM-RA001-1401	ROAD / MTB	BLACK	156.0g/pcs	DEGREE: ±8° / LENGTH: 140mm For Fork 1-1/4" / Bar-bore 35mm / with carbon shim & top cap

## SM-RA002

Full CNC made, unique light weight stem.  
 Alloy 6066 material effectively enhances the overall strength to eliminate stress corrosion.  
 80mm ~ 140mm total 7 sizes.  
**Has been approved by EN test standards.**

Product Features:

- Material: Alloy 6066-T6
- Spec: 80~140mm
- Angle:  $\pm 6$  degree
- Fork stack height 40mm fork tube 28.6mm
- Handlebar clamp 31.8mm
- Weight: 122g/set ~ 145g/set (without TOP CAP)
- Pass EFBE test



P1306490 / P1306491  
 P1306492



MODEL	PRIMARY USES	COLOR	WEIGHT	FEATURES
SM-RA002-801	ROAD / MTB	BLACK	122.0g/pcs	DEGREE: $\pm 6^\circ$ / LENGTH: 80mm For Fork 1-1/8" / Bar-bore 31.8mm / with top cap
SM-RA002-901	ROAD / MTB	BLACK	124.0g/pcs	DEGREE: $\pm 6^\circ$ / LENGTH: 90mm For Fork 1-1/8" / Bar-bore 31.8mm / with top cap
SM-RA002-1001	ROAD / MTB	BLACK	128.5g/pcs	DEGREE: $\pm 6^\circ$ / LENGTH: 100mm For Fork 1-1/8" / Bar-bore 31.8mm / with top cap
SM-RA002-1101	ROAD / MTB	BLACK	131.5g/pcs	DEGREE: $\pm 6^\circ$ / LENGTH: 110mm For Fork 1-1/8" / Bar-bore 31.8mm / with top cap
SM-RA002-1201	ROAD / MTB	BLACK	138.5g/pcs	DEGREE: $\pm 6^\circ$ / LENGTH: 120mm For Fork 1-1/8" / Bar-bore 31.8mm / with top cap
SM-RA002-1301	ROAD / MTB	BLACK	140.0g/pcs	DEGREE: $\pm 6^\circ$ / LENGTH: 130mm For Fork 1-1/8" / Bar-bore 31.8mm / with top cap
SM-RA002-1401	ROAD / MTB	BLACK	145.0g/pcs	DEGREE: $\pm 6^\circ$ / LENGTH: 140mm For Fork 1-1/8" / Bar-bore 31.8mm / with top cap



## SM-RA003

AL6066-T6 3D forged body. Then precision CNC machined ribs inside the stem body to remove excess weight while retaining rigidity. Patent technology.

Product Features:

- Material: AL6066-T6 3D forged + CNC made
- Bar-bore Ø31.8; Steerer tube Ø28.6
- Fork stack height 40mm
- Angle : ±6°
- Length: 70~120mm
- Weight: 119g/set ~ 152.5g/set (without TOP CAP)



MODEL	PRIMARY USES	COLOR	WEIGHT	FEATURES
SM-RA003-701	ALL MODELS	Sandblast Black	119g/set	DEGREE: ±6° / LENGTH: 70mm / For Fork 1-1/8" / Bar-bore 31.8mm / With top cap
SM-RA003-801	ALL MODELS	Sandblast Black	124g/set	DEGREE: ±6° / LENGTH: 80mm / For Fork 1-1/8" / Bar-bore 31.8mm / With top cap
SM-RA003-901	ALL MODELS	Sandblast Black	130g/set	DEGREE: ±6° / LENGTH: 90mm / For Fork 1-1/8" / Bar-bore 31.8mm / With top cap
SM-RA003-1001	ALL MODELS	Sandblast Black	133g/set	DEGREE: ±6° / LENGTH: 100mm / For Fork 1-1/8" / Bar-bore 31.8mm / With top cap
SM-RA003-1101	ALL MODELS	Sandblast Black	145g/set	DEGREE: ±6° / LENGTH: 110mm / For Fork 1-1/8" / Bar-bore 31.8mm / With top cap
SM-RA003-1201	ALL MODELS	Sandblast Black	152.5g/set	DEGREE: ±6° / LENGTH: 120mm / For Fork 1-1/8" / Bar-bore 31.8mm / With top cap

## SM-MB001

Full CNC made, unique light weight.  
 Extra big barbore Ø35mm for extra strength.  
 Has been approved by EN test standards.

Product Features:

- Material: Alloy 6061-T6
- Angle: 0 degree
- Length: 50mm
- Fork stack height: 40mm fork tube 31.8mm
- Handlebar clamp: 35mm
- With SHIM (AC-S001) - fork tube Ø31.8 change to Ø28.6  
 SHIM (AC-S002) - handlebar clamp Ø35 change to Ø31.8
- Weight: 205g (without TOP CAP)



MODEL	PRIMARY USES	COLOR	WEIGHT	FEATURES
SM-MB001-501	DOWNHILL / FREE RIDE / 4X	BLACK	205.0g/pcs	DEGREE: 0° / LENGTH: 50mm For Fork 1-1/4" / Bar-bore 35mm / with carbon shim & top cap

## SM-MB002



CNC machined.

Extra big barbore 35mm for added strength.

Has been approved by EN test standards.

Product Features:

- Material: Alloy 6061-T6
- Angle: 0 degree
- Length: 40-70mm
- Fork stack height 40mm fork tube 31.8mm
- Handlebar clamp 35mm
- With SHIM (AC-S001) - fork tube  $\varnothing 31.8$  change to  $\varnothing 28.6$   
SHIM (AC-S002) - handlebar clamp  $\varnothing 35$  change to  $\varnothing 31.8$
- Weight: 139.5g/set~175g/set (without TOP CAP)
- Color:



-----  
painted



-----  
anodize



AC-S002



AC-S001



MODEL	PRIMARY USES	COLOR	WEIGHT	FEATURES
SM-MB002	MTB	BLACK / PAINTED NEON GREEN / PAINTED NEON ORANGE / PAINTED BLACK / PAINTED WHITE / PAINTED BLUE / PAINTED RED	139.5g~175 g/pcs	DEGREE: 0° / LENGTH: 40mm, 50mm, 60mm, 70mm / For Fork 1-1/4" / Bar-bore 35mm / with carbon shim & top cap

## SM-MB003

Full CNC made, unique light weight design.  
Bar bore size of Ø35mm can improve stiffness with a Ø35mm handlebar.

Direct mount design for downhill forks.

Has been approved by EN test standards.

### Product Features:

- Material: Alloy 6061-T6
- Offset height: 25mm
- Direct mount: boxxer
- Handlebar clamp 35mm
- With SHIM (AC-S002) - handlebar clamp Ø35 change to Ø31.8
- Weight: 171g



MODEL	PRIMARY USES	COLOR	WEIGHT	FEATURES
SM-MB003-001	DOWNHILL	BLACK	171.0g/pcs	Offset height: 25mm / Bar-bore 35mm Direct mount: boxxer / With carbon shim
SM-MB003-005	DOWNHILL	GRAY	171.0g/pcs	Offset height: 25mm / Bar-bore 35mm Direct mount: boxxer / With carbon shim



## SM-MB005

Using high-strength aluminum alloy 6066-T6, this stem has a truly custom look and feel. The squared shape design with the forged cap provides great rigidity.

Has been approved by EN test standards.

Product Features:

- For MTB
- Material: Alloy 6066-T6 full CNC made
- Bar-bore Ø31.8; Steerer tube Ø28.6
- Angle: 0 degree
- Length: 60-120mm
- Integrated top cap included
- Weight: 144g/set ~ 210g/set (with TOP CAP)



MODEL	PRIMARY USES	COLOR	WEIGHT	FEATURES
SM-MB005-601	MTB	BLACK	144g/set	DEGREE: 0° / Length: 60mm / For Fork 1-1/8" / Bar-bore Ø31.8 / Integrated top cap included
SM-MB005-701	MTB	BLACK	154g/set	DEGREE: 0° / Length: 70mm / For Fork 1-1/8" / Bar-bore Ø31.8 / Integrated top cap included
SM-MB005-801	MTB	BLACK	165g/set	DEGREE: 0° / Length: 80mm / For Fork 1-1/8" / Bar-bore Ø31.8 / Integrated top cap included
SM-MB005-901	MTB	BLACK	176g/set	DEGREE: 0° / Length: 90mm / For Fork 1-1/8" / Bar-bore Ø31.8 / Integrated top cap included
SM-MB005-1001	MTB	BLACK	187g/set	DEGREE: 0° / Length: 100mm / For Fork 1-1/8" / Bar-bore Ø31.8 / Integrated top cap included
SM-MB005-1101	MTB	BLACK	198g/set	DEGREE: 0° / Length: 110mm / For Fork 1-1/8" / Bar-bore Ø31.8 / Integrated top cap included
SM-MB005-1201	MTB	BLACK	210g/set	DEGREE: 0° / Length: 120mm / For Fork 1-1/8" / Bar-bore Ø31.8 / Integrated top cap included

## SM-MB006

Flip flop stem with custom top cap and bottom cap design.  
 The dual anodized color design gives this stem a custom feel.  
 Made of high-strength 6061-T6 alloy CNC machining.  
 Has been approved by EN test standards.

Product Features:

- For MTB
- Material: Alloy 6061-T6 full CNC made
- Bar-bore Ø31.8; Steerer tube Ø28.6
- Angle: ±6 degree
- Length: 60-100mm
- With top cap and bottom cap
- Weight: 204.5g/set ~ 281.5g/set (with CAP)



MODEL	PRIMARY USES	COLOR	WEIGHT	FEATURES
SM-MB006-601	MTB	BLACK	204.5g/set	DEGREE: ±6° / Length: 60mm / For Fork 1-1/8" / Bar-bore Ø31.8 / With top cap and bottom cap
SM-MB006-701	MTB	BLACK	223.5g/set	DEGREE: ±6° / Length: 70mm / For Fork 1-1/8" / Bar-bore Ø31.8 / With top cap and bottom cap
SM-MB006-801	MTB	BLACK	242.5g/set	DEGREE: ±6° / Length: 80mm / For Fork 1-1/8" / Bar-bore Ø31.8 / With top cap and bottom cap
SM-MB006-901	MTB	BLACK	261.5g/set	DEGREE: ±6° / Length: 90mm / For Fork 1-1/8" / Bar-bore Ø31.8 / With top cap and bottom cap
SM-MB006-1001	MTB	BLACK	281.5g/set	DEGREE: ±6° / Length: 100mm / For Fork 1-1/8" / Bar-bore Ø31.8 / With top cap and bottom cap

## HA-S007

Easily change your handlebar height to adjust your riding position. Comes with screw, cap, and spacer.

Has been approved by EN test with stem.

Product Features:

- Steering tube extension for Ø28.6 fork
- Material: Alloy 6061-T6 body, Top cap, Spacer / Alloy 7075 long screw
- Length: 50mm (Adjust height 47.5mm ~ 65.5mm)  
90mm (Adjust height 47.5mm ~ 105.5mm)  
120mm (Adjust height 47.5mm ~ 135.5mm)
- Color: Sandblast black anodize
- Weight: 154g/set (50mm) / 192g/set (90mm) / 230g/set (120mm)

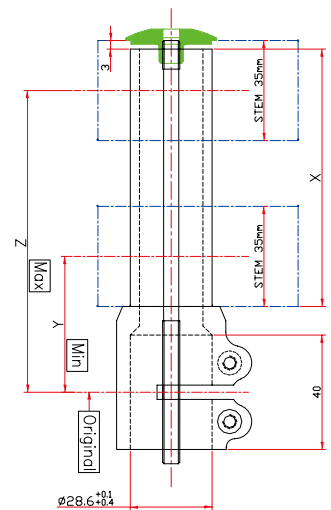

X	Y	Z
50	47.5	65.5
90	47.5	105.5
120	47.5	135.5

MODEL	PRIMARY USES	COLOR	WEIGHT	FEATURES
HA-S007-5101	ALL MODELS	S.B BLACK	154g/set	Adjust height 47.5mm ~ 65.5mm / With long screw, spacer & cap
HA-S007-9101	ALL MODELS	S.B BLACK	192g/set	Adjust height 47.5mm ~ 105.5mm / With long screw, spacer & cap
HA-S007-12101	ALL MODELS	S.B BLACK	230g/set	Adjust height 47.5mm ~ 135.5mm / With long screw, spacer & cap

# SEATPOST

Our carbon fiber seatposts add to your comfort while riding. Our specially designed carbon clamps also prevent over tightening damage to your saddle's rail commonly found when using metal clamps.

For DI2 battery holder

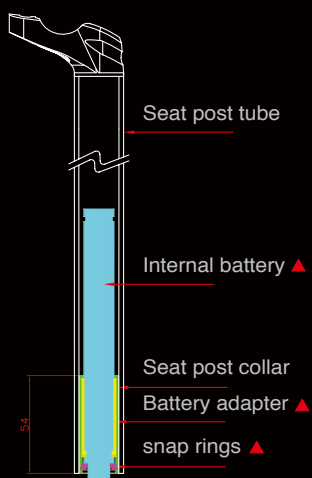

▲ SHIMANO parts





**SP-S001**  
**SP-S001-DI2**

CARBON

Carbon fiber seatposts is one of the best choices to reduce road vibrations. One piece monocoque carbon tube with carbon top clamp as well. Double bolt clamping design.

Product Features:

- Material: UD Carbon fiber
- Spec: Ø27.2 or Ø30.9, Ø31.6
- Length: 350 or 400mm
- Offset: 20mm
- Weight: 200g (Ø31.6 350mm)
- Option: SP-S001-DI2 (For SHIMANO® DI2 battery holder)
- Pass EFBE test



**SP-S002**  
**SP-S002-DI2**

CARBON

Carbon seatpost with CNC alloy head. Carbon top clamp. Double bolt design for easy angle adjustment.

Product Features:

- Material: Alloy 6061-T6 body  
UD Carbon tube  
Carbon saddle clamp
- Spec: Ø27.2 or Ø30.9, Ø31.6
- Length: 350 or 400mm
- Offset: 20mm
- Weight: 235g (Ø31.6 350mm)
- Option: SP-S002-DI2 (For SHIMANO® DI2 battery holder)
- Pass EFBE test



**SP-S003**  
**SP-S003-DI2**

CARBON

Full carbon fiber seatpost with one piece monocoque carbon top clamp. Double bolt design for easy angle adjustment.

Product Features:

- Material: Carbon Monocoque Construction  
Carbon clamp
- Spec: Ø27.2 or Ø30.9, Ø31.6
- Length: 350 or 400mm
- Offset: 0mm
- Weight: 190g (Ø31.6 350mm)
- Option: SP-S003-DI2 (For SHIMANO® DI2 battery holder)

**EFBE**  
PRÜFTECHNIK

P1206092 / P1206093  
Pass overload 300 kg

**EFBE**  
PRÜFTECHNIK

P1206037 / P1206038  
Pass overload 300 kg

MODEL	PRIMARY USES	COLOR	WEIGHT	FEATURES
SP-S001	ALL MODELS	CARBON UD	187g~213g	OD: Ø27.2mm, Ø30.9mm or Ø31.6mm / LENGTH: 350mm or 400mm / OFFSET: 20mm
SP-S001-DI2	ALL MODELS	CARBON UD	200g~253g	OD: Ø27.2mm, Ø30.9mm or Ø31.6mm / LENGTH: 350mm or 400mm / OFFSET: 20mm
SP-S002	ALL MODELS	CARBON UD	227g~260g	OD: Ø27.2mm, Ø30.9mm or Ø31.6mm / LENGTH: 350mm or 400mm / OFFSET: 20mm
SP-S002-DI2	ALL MODELS	CARBON UD	241g~300g	OD: Ø27.2mm, Ø30.9mm or Ø31.6mm / LENGTH: 350mm or 400mm / OFFSET: 20mm
SP-S003	ALL MODELS	CARBON UD	178g~205g	OD: Ø27.2mm, Ø30.9mm or Ø31.6mm / LENGTH: 350mm or 400mm / OFFSET: 0mm
SP-S003-DI2	ALL MODELS	CARBON UD	192g~245g	OD: Ø27.2mm, Ø30.9mm or Ø31.6mm / LENGTH: 350mm or 400mm / OFFSET: 0mm



The carbon clamp tighten torque please follow the warning sticker

# SEATPOST



## SP-E001

### ALLOY

Economic, strong, and good looking alloy seatpost. Double screw locking for angle adjustment.

#### Product Features:

- Material: Alloy 6061-T6 body  
Alloy 6066-T6 tube  
Alloy 6061-T6 saddle clamp
- Spec: Ø27.2mm or Ø31.6mm
- Length: 350 or 400mm
- Offset: 20mm
- Color: Sandblast black anodized
- Weight: 310g (Ø31.6 350mm)



## SP-E002

### ALLOY

3D forged good looking high strength alloy seatpost with double screw locking for angle adjustment.

#### Product Features:

- Material: 3D forged AL6061-T6 body  
AL6061-T6 clamp
- Spec: Ø27.2mm or Ø31.6mm
- Length: 350 or 400mm
- Offset: 20mm
- Weight: 330g (Ø31.6 350mm)



## AC-S007

### ALLOY

This is a lightweight seatpost shim. It is used to make your seatpost fit into your oversized seat tube.

#### Product Features:

- Material: AL6061-T6
- Spec: OD Ø31.6mm x ID Ø30.9mm (Length:90mm)  
OD Ø31.6mm x ID Ø27.2mm (Length:80mm)  
OD Ø30.9mm x ID Ø27.2mm (Length:90mm)
- Color: black, silver
- Weight: 9g~41g

MODEL	PRIMARY USES	COLOR	WEIGHT	FEATURES
SP-E001	ALL MODELS	BLACK	310g~353g	OD: Ø27.2mm or Ø31.6mm / LENGTH: 350mm or 400mm / OFFSET: 20mm
SP-E002	ALL MODELS	BLACK	320g~363g	OD: Ø27.2mm or Ø31.6mm / LENGTH: 350mm or 400mm / OFFSET: 20mm
AC-S007	ALL MODELS	BLACK / SILVER	9g~41g	Seatpost shim/ OD Ø31.6mm x ID Ø30.9mm (Length: 90mm) or OD Ø31.6mm x ID Ø27.2mm (Length:80mm) or OD Ø30.9mm x ID Ø27.2mm (Length:90mm)

## BB-DX001

Fit PressFit 30 frame (Ø46mm x 68 / 73mm)  
Eccentric 8mm from bottom bracket center to crankset center.

Product Features:

- Fit PressFit 30 frame
- Eccentric 8mm
- Material: AL6061-T6
- With: Enduro® seal bearing (Ø37 x Ø25 x 7mm) x 2,  
M5 x 70mm screw x2
- Weight: 151g/set



## BB-S001

Fit PressFit 30 frame (Ø46mm x 68/73mm) to  
BB30 crankset (30mm axle).

Product Features:

- Material: Plastic bearing cup, Alloy side cover
- With: Enduro® Seal bearing (Ø42 x Ø30 x 7mm) x 2,  
wave washer x1
- Spacer: 2.5mm spacer x 2, 0.5mm spacer x 3
- Weight: 83g/set

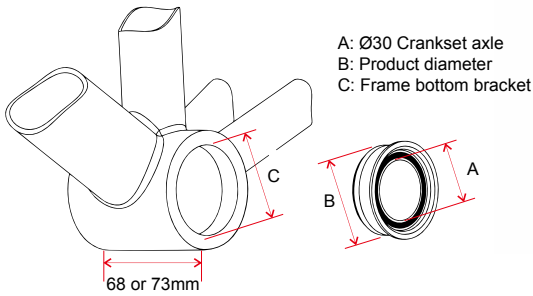

Product name	Product diameter	Frame bottom bracket diameter
BB-S001-010	Ø46 +0.13 +0.11	Ø46 +0.1 +0.06
BB-S001-005	Ø46 +0.08 +0.06	Ø46 +0.05 +0.01
BB-S001-001	Ø46 +0.06 +0.02	Ø46 +0.0 -0.05 (Standard)

MODEL	PRIMARY USES	COLOR	WEIGHT	FEATURES
BB-DX001-SH001	FRAME	BLACK	151g/set	Eccentric 8mm from bottom bracket center to crankset center / Fix SHIMANO
BB-DX001-SR101	FRAME	BLACK	151g/set	Eccentric 8mm from bottom bracket center to crankset center / Fix SRAM
BB-S001-001	FRAME	BLACK	83g/set	Fit PressFit 30 frame \ BB30 crankset / Frame bottom bracket diameter Ø46 +0/-0.05 (Standard)
BB-S001-005	FRAME	BLACK	83g/set	Fit PressFit 30 frame \ BB30 crankset / Frame bottom bracket diameter Ø46 +0.01/+0.05
BB-S001-010	FRAME	BLACK	83g/set	Fit PressFit 30 frame \ BB30 crankset / Frame bottom bracket diameter Ø46 +0.06/+0.1

# BRAKE

Single-axis design to reduce the weight of whole brake set.

With ti-64 titanium screws.

Ball bearings in brake pivot.

Alloy 6066 material effectively enhance the overall strength and improve hard to stress corrosion.







# ROAD BRAKE

## BR-DX001 Titanium Axle

The use of leverage increases the braking force and the single-axis design to reduce the weight throughout the whole brake set. Alloy 6066 material effectively enhance the overall strength and improved corrosion resistance. The weight of the whole brake set is being further improved by using **ti-64 titanium** screws. Full CNC manufacturing comes out with a precision appearance and with spot on tolerances.

Collocate with the Swiss Stop brake shoes.  
Approved by EN test standards.

### Product Features:

- Material: Alloy 6066-T6 CNC made
- Brake shoes: CNC cassette
- Bolt: main **bolt ti-64**
- Dimension: c-c 39-51mm
- Option: Swiss Stop carbon rim pads available
- Color: polish anodize
- Weight: 210g/set



## BR-S003

The use of leverage increases the braking force and the single-axis design to reduce the weight throughout the whole brake set. Alloy 6066 material effectively enhance the overall strength and improved corrosion resistance.  
Approved by EN test standards.

### Product Features:

- Material: Alloy 6066-T6 forged cnc made
- Brake shoes: Forged cassette
- Bolt: main **bolt Cr-Mo**
- Dimension: c-c 39-51mm
- Option: Ashima carbon rim pads available
- Color: polish anodize
- Weight: 230g/set



MODEL	PRIMARY USES	COLOR	WEIGHT	FEATURES
BR-DX001	ROAD BIKE	BLACK / SILVER RED / GOLD / GRAY	210g/set	REACH: C-C 39~51mm
BR-S003	ROAD BIKE	BLACK / SILVER RED / GOLD / GRAY	230g/set	REACH: C-C 39~51mm

## BR-DX005

Our CNC machined aero brake cooperation is used by one of the best cycle team in the world. We design the best geometry to make the rider feel more aerodynamics and the best brake faction.

Product Features:

- Fits GIANT® PROPEL
- Direct mount aero V brake
- Liner spring adjuster system
- Quick adjuster different rims width
- Use SWISS STOP® brake shoes
- Material: AL6061-T6
- Weight: 270g/set
- Color: black, silver



## BR-DX002

CNC machined  
Unique shape and light weight.  
Balance spring power adjustable.

Product Features:

- Standard V-brake design
- Material: Alloy 7075-T6
- Color: Polished black anodize
- **Weight: 300g/set**



Balance spring power adjustable



MODEL	PRIMARY USES	COLOR	WEIGHT	FEATURES
BR-DX005	GIANT® PROPEL	BLACK / SILVER	270g/set	Fix GIANT® PROPEL / Quick adjuster different rims width
BR-DX002	MTB	BLACK / SILVER RED / GOLD / GRAY	300g/set	ALLOY 7075-T6, ARM LENGTH 98mm

# DISC ROTOR

## BR-DC001

Disc brake rotor. Compatible with the international standard 6 hole (IS mount), coupled with lightweight stainless steel disc shape of the center piece made of aluminum alloy 7075-T651.

Product Features:

- Material: Stainless steel body, AL7075-T651 adapter
- OD Size: Ø160, Ø180
- Thickness: 2mm
- Weight: Ø160mm: 112.5g  
Ø180mm: 143g



## BR-DC002

Disc brake rotor. Compatible with the international standard 6 hole (IS mount), coupled with lightweight stainless steel disc shape of the center piece made of aluminum alloy 7075-T651.

Product Features:

- Material: Stainless steel body, AL7075-T651 adapter
- OD Size: Ø160, Ø180
- Thickness: 2mm
- Weight: Ø160mm: 107g  
Ø180mm: 139g

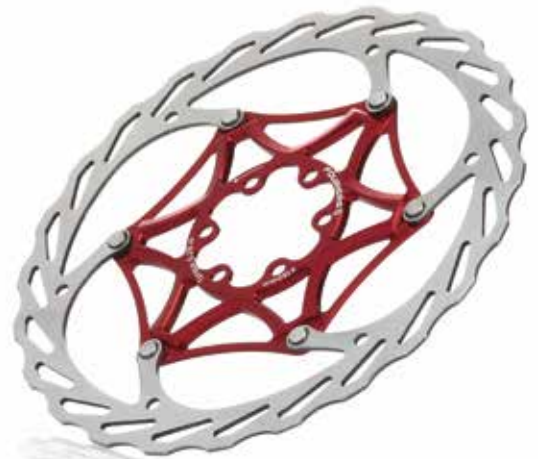

MODEL	PRIMARY USES	COLOR	WEIGHT	FEATURES
BR-DC001	MTB	BLACK / RED / GRAY	112.5g~141.0g	Compatible with the international standard 6 hole (IS mount)/ OD: Ø160 or Ø180
BR-DC002	MTB	BLACK / RED / GRAY	106.5g~146.5g	Compatible with the international standard 6 hole (IS mount)/ OD: Ø160 or Ø180

## BR-DCS001

Disc brake rotor. Compatible with the international standard 6 hole (IS mount).

Product Features:

- Material: Stainless steel
- OD Size: Ø160, Ø180
- Thickness: 2mm
- Weight: Ø160mm: 113g  
Ø180mm: 143g



## BR-DCS002

Disc brake rotor. Compatible with the international standard 6 hole (IS mount).

Product Features:

- Material: Stainless steel
- OD Size: Ø160
- Thickness: 2mm
- Weight: 108.5g



## BR-DCS003

Disc brake rotor. Compatible with the international standard 6 hole (IS mount).

Product Features:

- Material: Stainless steel
- OD Size: Ø180
- Thickness: 2mm
- Weight: 107g

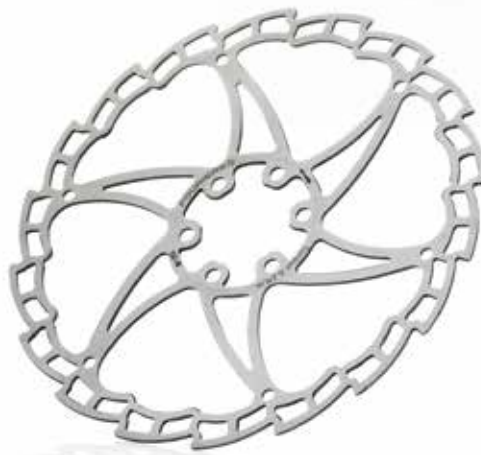

MODEL	PRIMARY USES	COLOR	WEIGHT	FEATURES
BR-DCS001	MTB	Stainless steel	113g~138g	Compatible with the international standard 6 hole (IS mount)/ OD: Ø160 or Ø180
BR-DCS002	MTB	Stainless steel	108.5g	Compatible with the international standard 6 hole (IS mount)/ OD: Ø160
BR-DCS003	MTB	Stainless steel	107g	Compatible with the international standard 6 hole (IS mount)/ OD: Ø180

# BRAKE PADS



## BR-E001 Titanium Bolt

CNC machined.  
Titanium bolt.  
Brake pads special for carbon rim.  
Angle adjustable with curve washer.

### Product Features:

- Compatible with SHIMANO caliper system
- Material: Alloy 6066-T6
- Weight: 59g/set



## BR-E006

Forged with CNC made  
stainless steel bolt brake pads special for alloy rim.  
Angle adjustable with curve washer.

### Product Features:

- Compatible with SHIMANO caliper system
- Material: Alloy 6061-T6
- Weight: 71g/set



## BR-E007

Forged with CNC made  
stainless steel bolt brake pads special for alloy rim.  
Angle adjustable with curve washer.

### Product Features:

- Compatible with SHIMANO caliper system
- Material: Alloy 6061-T6
- Weight: 70g/set

MODEL	PRIMARY USES	COLOR	WEIGHT	FEATURES
BR-E001-001	ROAD BIKE	BLACK	59g/set	Fits SHIMANO
BR-E001-002	ROAD BIKE	SILVER	59g/set	Fits SHIMANO
BR-E001-003	ROAD BIKE	RED	59g/set	Fits SHIMANO
BR-E006-001	ROAD BIKE	BLACK	71g/set	Fix SHIMANO
BR-E006-002	ROAD BIKE	SILVER	71g/set	Fix SHIMANO
BR-E006-003	ROAD BIKE	RED	71g/set	Fix SHIMANO
BR-E007-001	ROAD BIKE	BLACK	70g/set	Fix SHIMANO
BR-E007-002	ROAD BIKE	SILVER	70g/set	Fix SHIMANO
BR-E007-003	ROAD BIKE	RED	70g/set	Fix SHIMANO



## BR-DX003

Full CNC machined. Light weight design V-brake lever. Fits SHIMANO standard brake cable.

Product Features:

- Material: Alloy 6066-T6
- For Ø24 handlebar w/i Ø22.2 shim
- **Weight: 70g/pair**
- Color: black, red



## BR-DX004

Full CNC machined. Light weight design brake lever. For Caliper-brake lever, Canti-brake lever, Mini V-brake lever fits SHIMANO standard brake cable.

Product Features:

- Material: Alloy 6066-T6
- For Ø24 handlebar w/i Ø22.2 shim
- **Weight: 85g/pair**
- Color: black, red



MODEL	PRIMARY USES	COLOR	WEIGHT	FEATURES
BR-DX003-001	V-BRAKE SYSTEM	BLACK	70g/pair	Fits SHIMANO standard brake cable
BR-DX003-003	V-BRAKE SYSTEM	RED	70g/pair	Fits SHIMANO standard brake cable
BR-DX004-001	CANTI-BRAKE SYSTEM	BLACK	85g/pair	Fits SHIMANO standard brake cable
BR-DX004-003	CANTI-BRAKE SYSTEM	RED	85g/pair	Fits SHIMANO standard brake cable

# QUICK RELEASE

## QR-DX001 CARBON LEVER / Titanium Axle

Super lightweight quick release, titanium axle, alloy body & carbon lever bonded perfectly.

### Product Features:

- Alloy with carbon fiber lever
- Cap washer and nut anodized finish
- **Titanium** axle ED black finish
- With FOURIERS logo
- **Weight: 43g/set (ROAD BIKE) / 46g/set (MTB)**
- Color available: black, silver, red, gold, gray
- For ROAD BIKE or MTB



MODEL	PRIMARY USES	COLOR	WEIGHT	FEATURES
QR-DX001-001	ROAD BIKE	BLACK	43g/set	O.L.D: (F)100mm (R)130mm
QR-DX001-002	ROAD BIKE	SILVER	43g/set	O.L.D: (F)100mm (R)130mm
QR-DX001-003	ROAD BIKE	RED	43g/set	O.L.D: (F)100mm (R)130mm
QR-DX001-004	ROAD BIKE	GOLD	43g/set	O.L.D: (F)100mm (R)130mm
QR-DX001-005	ROAD BIKE	GRAY	43g/set	O.L.D: (F)100mm (R)130mm
QR-DX001-101	MTB	BLACK	46g/set	O.L.D: (F)100mm (R)135mm
QR-DX001-102	MTB	SILVER	46g/set	O.L.D: (F)100mm (R)135mm
QR-DX001-103	MTB	RED	46g/set	O.L.D: (F)100mm (R)135mm
QR-DX001-104	MTB	GOLD	46g/set	O.L.D: (F)100mm (R)135mm
QR-DX001-105	MTB	GRAY	46g/set	O.L.D: (F)100mm (R)135mm

## QR-E001

Economic quick release / classic design.

Product Features:

- Alloy lever made anodized finish
- 10B21 axle
- With FOURIERS logo
- Weight: 112g/set (ROAD BIKE) / 115g/set (MTB)
- Color: Sandblast black or silver anodize
- For ROAD BIKE or MTB



## QR-E002

Aircraft aluminum lever, internal cam system. The high intensity quick release.

Product Features:

- Material: Aircraft aluminum lever, Cr-mo axle
- Weight: 124.5~126.5g/set
- Color: black, silver, red, gold, gray
- For MTB or ROAD BIKE



MODEL	PRIMARY USES	COLOR	WEIGHT	FEATURES
QR-E001	ROAD BIKE / MTB	BLACK / SILVER	112g/set~115g/set	O.L.D: (F)100mm (R)130mm or 135mm
QR-E002	ROAD BIKE / MTB	BLACK / SILVER / RED GOLD / GRAY	124.5g/set~126.5g/set	O.L.D: (F)100mm (R)130mm or 135mm

# QUICK RELEASE

## QR-S001 Titanium Axle

Lightweight design aluminum with quick release. Perfect combination with the ultra lightweight lever.

Product Features:

- Alloy full CNC machined lever
- Cap washer and nut anodized finish
- **Titanium** axle ED black finish
- With FOURIERS logo
- **Weight: 45g/set (ROAD BIKE) / 47g/set (MTB)**
- Color available: black, silver, red, gold, gray
- For ROAD BIKE or MTB



## QR-S002 Titanium Axle

Lightweight design with a sleek aluminum quick release lever. Perfect combination for an ultra lightweight QR.

Product Features:

- Alloy full CNC machined lever
- Cap washer and nut anodized finish
- **Titanium** axle ED black finish
- With FOURIERS logo
- **Weight: 53.0g/set (ROAD BIKE) / 56.0g/set (MTB)**
- Color available: black, silver, red, gold, gray
- For ROAD BIKE or MTB



## QR-S005

Perfect Carbon and aluminum fusion with this internal cam system. High intensity both lightweight and artist product.

Product Features:

- Material: Alloy and Carbon bonded lever  
Cr-mo axle
- **Weight: 112g (ROAD BIKE bike), 114g (MTB)**
- Color: black, silver, red, gold, gray



MODEL	PRIMARY USES	COLOR	WEIGHT	FEATURES
QR-S001	ROAD BIKE / MTB	BLACK / SILVER / RED GOLD / GRAY	45g/set~47g/set	O.L.D: (F)100mm (R)130mm or 135mm
QR-S002	ROAD BIKE / MTB	BLACK / SILVER / RED GOLD / GRAY	53g/set~56g/set	O.L.D: (F)100mm (R)130mm or 135mm
QR-S005	ROAD BIKE / MTB	BLACK / SILVER / RED GOLD / GRAY	112g/set~115g/set	O.L.D: (F)100mm (R)130mm or 135mm

## QR-S003

Alloy 12mm full CNC machined axle and lever.  
The high intensity both lightweight and art products.

Product Features:

- Alloy lever with anodized finished
- Cap washer and nut made anodize color
- Alloy 7075-T6 12mm axle anodized color
- With FOURIERS logo
- For 135mm HUB, 142mm HUB, 150mm HUB
- Weight: 75g/set

HUB	AXLE	SPEC
135	168	M12 x 1.75
142 (SHIMANO)	171	M12 x 1.5
150	183	M12 x 1.75



## QR-S004

Thru-axle system for extreme riding conditions.  
Full CNC machined alloy lever can be adjusted for repositioned simply by lifting.

Product Features:

- For MTB
- Material: AL7075 axle / AL6061 lever
- Spec: Ø12mm axle / 135mm, 142mm, 150mm HUB  
Ø15mm axle with nut
- Max force to 150kgf-cm
- Weight: 83g/pcs
- Color: black, red

HUB	AXLE	SPEC
100 (SHIMANO)	146	M14 x 1.5
135	168	M12 x 1.75
142 (SHIMANO)	171	M12 x 1.5
150	183	M12 x 1.75

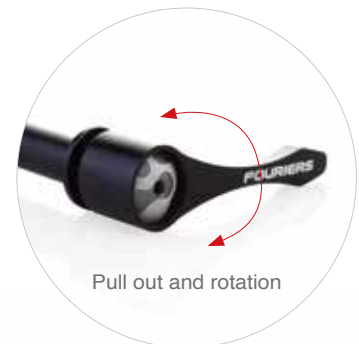

MODEL	PRIMARY USES	COLOR	WEIGHT	FEATURES
QR-S003	MTB	BLACK / RED	75g/pcs	Fits Ø12mm / 135mm, 142mm(SHIMANO), 150mm HUB
QR-S004	MTB	BLACK / RED	80.5g/pcs	Fits Ø12mm / 135mm, 142mm(SHIMANO), 150mm HUB, Ø15mm x 100mm HUB



# CHAIN GUIDE

## CT-DX005-ISCG CT-DX005-ISCG05

Lightweight chain guide with bash guard /  
Bash guard made by strong plastic material from Switzerland.

**Product Features:**

- Spec: ISCG or ISCG-05
- With 10 speed plastic kit
- Material: Alloy 6061-T6
- BB adapter included (for e type BB mount)
- Range: 32t ~ 38t
- Weight: 210g
- Color: black, red anodize

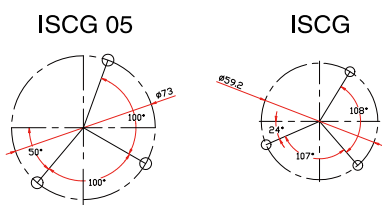

## CT-DX006-ISCG CT-DX006-ISCG-05

Dual guide for 2X system / Direct mount bash guard integrated to  
protect your drivetrain, plastic roller design.

**Product Features:**

- Material: Alloy 6061-T6
- Spec: ISCG or ISCG-05
- BB adapter included (for e type BB mount)
- Range: 28t ~ 40t
- Weight: 142g
- Color: black, red anodize

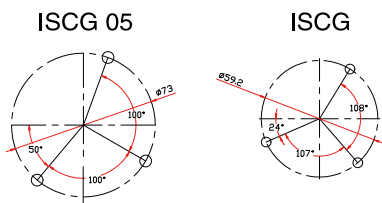

MODEL	PRIMARY USES	COLOR	WEIGHT	FEATURES
CT-DX005-001	FREE RIDE / D.H / 4X	BLACK / RED	210g/pcs	For 32T to 38T / ISCG or ISCG-05
CT-DX006-001	MTB / 2X / XC	BLACK / RED	142g/pcs	For 28T to 40T / ISCG or ISCG-05

## CT-DX001-ISCG CT-DX001-ISCG05

Lightweight chain guide with fully incased cage so there is no need for a bash plate. Sports an aluminium back plate with adjustable strong-hardened plastic material for the top and bottom guides. Takes chainring sizes from 32t to 40t. Sealed bearing bottom roller makes this guide super smooth.

### Product Features:

- With 10 speed plastic kit
- Material: Alloy 6061-T6
- Spec: ISCG or ISCG-05
- BB adapter included (for e type BB mount)
- Size: 32t ~ 40t
- Weight: 162g (without adapter)
- Color: black, red



ISCG 05

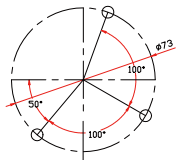

ISCG

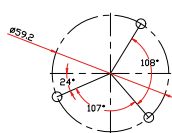

## CT-DX002-ISCG CT-DX002-ISCG05

Lightweight chain guide with half caged upper arm guide design. For use with a bash guard. Sports an aluminium back plate with adjustable strong hardened plastic material for the top and bottom guides. Accepts 32t to 40t chainrings. Sealed bearing bottom roller makes this guide super smooth.

### Product Features:

- Material: Alloy 6061-T6
- Spec: ISCG or ISCG-05
- BB adapter included (for e type BB mount)
- Size: 32t ~ 40t
- Weight: 141.5g (without adapter)
- Color: black, red
- Note: bash plate no include



ISCG 05

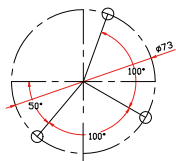

ISCG

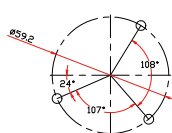

MODEL	PRIMARY USES	COLOR	WEIGHT	FEATURES
CT-DX001	FREE RIDE / D.H / 4X	BLACK / RED	162g/pcs	For 32t to 40t / ISCG or ISCG-05
CT-DX002	FREE RIDE / D.H / 4X	BLACK / RED	142g/pcs	For 32t to 40t / ISCG or ISCG-05

# CHAIN GUIDE

## CT-DX003-ISCG CT-DX003-ISCG05

Strong single lower arm chain guide with CNC cuts in backplate for weight reduction / backplate made of aluminium. Roller with sealed bearing / together with a bashguard, this may be used for double chainring drives. Includes BB adapter and adjustable silent step roller.

Product Features:

- Material: Alloy 6061-T6
- Spec: ISCG or ISCG-05
- BB adapter included (for e type BB mount)
- Thickness: 4mm
- Size: 32t ~ 40t
- Weight: 95g (with out adapter)
- Color: black, red



ISCG 05

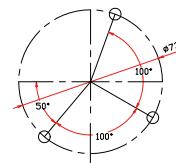

ISCG

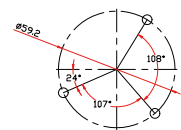

## CT-DX004

Chain guide design for MTB 1x9 or 1x10 Drive train. Light weight design, easy for adjustment from 32t to 40t includes spacers for fine chainline. Only fit for BB e-type mount version. Super strong fully caged plastic chain guide on the top.

Product Features:

- With 10 speed plastic kit
- Material: Alloy 6061-T6
- Teeth: 32t ~ 40t
- Weight: 80g
- Color: black, red



## AC-S003

Use this chain catcher to protect your BB and chain. This helps prevent the chain from dropping when you shift the front chainwheel during high speed riding.

Product Features:

- Material: Alloy 6061-T6 Carbon coating
- Range: 39t ~ 53t, 34t ~ 50t
- Color: Carbon 3K
- Weight: 7.5g (without bolt)



MODEL	PRIMARY USES	COLOR	WEIGHT	FEATURES
CT-DX003	MTB / FREE RIDE / D.H / 4X	BLACK / RED	95g/pcs	For 32t to 40t / ISCG or ISCG-05
CT-DX004	MTB / FREE RIDE / D.H / 4X	BLACK / RED	80g/pcs	For 32t to 40t / For BB e-type
AC-S003-100	ROAD BIKE	Carbon 3K	7.5g/pcs	For 39t ~ 53t or 34t ~ 50t

## CG-DX001

Designed to protect your middle and inner chainring from impacts. Fully heat-treated aluminium with CNC releases for better mud clearance.

Product Features:

- Material: Alloy 6061-T6 CNC made
- P.C.D: 104mm
- Size: 32t (OD: 147mm)  
36t (OD: 160mm)  
38t ~ 40t (OD: 180mm)
- Thickness: 4mm
- Weight: 84.5g (36t ~ 37t)
- Color: black, red, gray



## CG-S001

Lightweight bash-guard with no holes . Polycarbonate with brass copper bushing construction / CNC made finished.

Product Features:

- Material: Poly carbonate CNC made
- P.C.D: 104mm
- Size: 36t (OD: 160mm)  
38t ~ 40t (OD: 180mm)
- Thickness: 10mm
- Weight: 113g (36t ~ 37t)



MODEL	PRIMARY USES	COLOR	WEIGHT	FEATURES
CG-DX001	MTB / FREE RIDE / D.H / 4X	BLACK / RED GRAY	85g~90g	For 32t (OD Ø147mm) or 36t (OD Ø160mm) or 38t ~ 40t (OD Ø180mm)
CG-S001	FREE RIDE / D.H / 4X	CLEAR	113g~170g	For 36t (OD Ø160mm) or 38t ~ 40t (OD Ø180mm)

# ACCESSORIES



## HA-S002 CARBON

CNC Machined.  
Ultra light alloy special double clamp.

Product Features:

- Material: Alloy 6061-T6
- For Ø31.8 handlebar
- Ø26 Carbon tube for computer mounting
- With FOURIERS logo
- Weight: 32g/pcs



## HA-S010

Compatible for GARMIN Edge®. It's more comfortable to watch your riding information.

Product Features:

- Compatible for GARMIN Edge® 810, 800, 510, 500, 200
- For Ø31.8 handle bar
- Arm length adjustable.
- Material: AL6061-T6 body, Plastic adapter
- Comes with Ø25.4 x Ø22.2 shim
- Weight: 40.5g
- Color: Sandblast anodized body, Black plastic adapter



MODEL	PRIMARY USES	COLOR	WEIGHT	FEATURES
HA-S002	ALL MODELS	3K	32g/pcs	Handlebar clamp Ø35 or Ø31.8 & computer mount Ø26
HA-S010	ALL MODELS	S.B BLACK / S.B RED / S.B GRAY	40.5g	Compatible for GARMIN Edge® 810, 800, 510, 500, 200





### HA-S011

Compatible for GARMIN Edge ®. It's more comfortable way to see your riding information. This adapter adds more protection to your GARMIN Edge® and helps prevent scratches.

**Product Features:**

- Compatible for GARMIN Edge ® 810, 800, 510, 500, 200
- Material: AL6061-T6 body, Plastic adapter
- For Triathlon arm rest Ø22.2 tube
- Weight: 42.5g
- Color: Sandblast anodized body, Black plastic adapter



### HA-S012

Custom made for the world renowned GoPro camera. Use this dedicated adapter to easily record your riding excitement.

**Product Features:**

- Compatible for GO PRO HERO, HERO2, HERO3
- For Ø31.8 handle bar
- With Ø25.4 & Ø22.2 shim
- Material: AL6061-T6 body
- Weight: 50g/set
- Color: Sandblast anodize body



MODEL	PRIMARY USES	COLOR	WEIGHT	FEATURES
HA-S011	ALL MODELS	S.B BLACK / S.B RED / S.B GRAY	42.5g	Compatible for GARMIN Edge ® 810, 800, 510, 500, 200
HA-S012	ALL MODELS	S.B BLACK / S.B RED / S.B GRAY	50g/set	Compatible for GO PRO-HERO, HERO2, HERO3

# TRIATHLON

Spring loaded aluminum arm pads that swing up and out of the way when you aren't using them. Very convenient for maintaining all your varied hand positions. With 300mm extensions, the length can be cut short for a more custom feel.

**Product Features:**

- Triathlon armrest
- Material: Alloy 6061-T6
- For Ø31.8 handlebar
- Weight: 507g/set

## HB-TR001-101C

With Carbon fiber S tube  
Angle 17° / 300mm  
(Only order S tube: HB-TUB-101C)



## HB-TR001-201C

With Carbon fiber J1 tube  
Angle 17° / 300mm  
(Only order J1 tube: HB-TUB-201C)



## HB-TR001-301C

With Carbon fiber J2 tube  
Angle 50° / 300mm  
(Only order J2 tube: HB-TUB-301C)



## HB-TR001-401C

With Carbon fiber I tube  
300mm  
(Only order I tube: HB-TUB-401C)



Armrests automatically swing up



MODEL	PRIMARY USES	COLOR	WEIGHT	FEATURES
HB-TR001-101C	ROAD BIKE / TRIATHLON	BLACK	507g/set	Fits Ø31.8 Bar-bore With S tubes
HB-TR001-201C	ROAD BIKE / TRIATHLON	BLACK	507g/set	Fits Ø31.8 Bar-bore With J1 tubes
HB-TR001-301C	ROAD BIKE / TRIATHLON	BLACK	507g/set	Fits Ø31.8 Bar-bore With J2 tubes
HB-TR001-401C	ROAD BIKE / TRIATHLON	BLACK	507g/set	Fits Ø31.8 Bar-bore With I tubes
HB-TUB	ROAD BIKE / TRIATHLON	CARBON 3K/UD	120g~140g/pair	OD: 22.2 / Fits triathlon bar / Option: S tubes, J1 tubes, J2 tubes, I tubes

Arm rest height adjustable. With 300mm extensions, length can be cut to desired position.

Product Features:

- Triathlon arm rest
- Material: Alloy 6061-T6 full CNC made
- For Ø31.8 handle bar
- Tubes Available: S tube, S2 tube, I tube, or J tube.
- Comes with an adapter to change the height from 20mm, 40mm, 60mm.
- Weight: 470g/set

**HB-TR003-101C**

With Carbon fiber S tube  
Angle 17° / 300mm  
(Only order S tube: HB-TUB-101C)



**HB-TR003-201C**

With Carbon fiber J1 tube  
Angle 17° / 300mm  
(Only order J1 tube: HB-TUB-201C)



**HB-TR003-301C**

With Carbon fiber J2 tube  
Angle 50° / 300mm  
(Only order J2 tube: HB-TUB-301C)



**HB-TR003-401C**

With Carbon fiber I tube  
300mm  
(Only order I tube: HB-TUB-401C)



Comes with an adapter to change the height



MODEL	PRIMARY USES	COLOR	WEIGHT	FEATURES
HB-TR003-101C	ROAD BIKE / TRIATHLON	BLACK	470g/set	Fits Ø31.8 Bar-bore With S tubes
HB-TR003-201C	ROAD BIKE / TRIATHLON	BLACK	470g/set	Fits Ø31.8 Bar-bore With J1 tubes
HB-TR003-301C	ROAD BIKE / TRIATHLON	BLACK	470g/set	Fits Ø31.8 Bar-bore With J2 tubes
HB-TR003-401C	ROAD BIKE / TRIATHLON	BLACK	470g/set	Fits Ø31.8 Bar-bore With I tubes
HB-TUB	ROAD BIKE / TRIATHLON	CARBON 3K/UD	120g~140g/pair	OD: 22.2 / Fits triathlon bar / Option: S tubes, J1 tubes, J2 tubes, I tubes

# TRIATHLON



## WBC-S001 CARBON

Specially designed aero water bottle cage. More in line with the competition! L size can hold 600cc of water and easier to extract! S size can hold 300cc energy drinks!

### Product Features:

- Material: Carbon UD cage+ Plastic water bottle
- Volume: (L) 600cc, (S) 300cc
- Weight: (L) 82.5g, (S) 62.5g, (CAGE) 26g



## WBC-S002 CARBON

Carbon fiber bottle cage retention system, with seat mounted adapter on the rear of the seat. Freely choose to install one or two bottle cages. Besides the cages, there is extra space for simple supplies storage. Provides the best solution for long-range riding. Is not recommended for use on carbon fiber railed saddles.

### Product Features:

- Material: Carbon fiber 3K, UD
- Saddle rear cage
- Not suggested for Carbon railed saddles
- With accessories strap and tool mount
- Weight: 208g



MODEL	PRIMARY USES	COLOR	WEIGHT	FEATURES
WBC-S001-100	ALL MODELS	CARBON 3K	175g/set	WATER BOTTLE & CAGE
WBC-S002-500	ALL MODELS	3K	208g/set	Carbon fiber bottle cage retention system
WBC-S002-600	ALL MODELS	UD	208g/set	Carbon fiber bottle cage retention system



### HB-TR002

Triathlon extension bars bridge.  
5mm pitch adjustable width. Maximum 20mm.  
Also features a Ø26mm computer mount.

Product Features:

- For Triathlon bar bridge
- Material: Nylon
- Width: 85mm-105mm
- Weight: 54g/set



### WBC-DX001

Water bottle cage adapter for a triathlon bar.  
Simple and effective.

Product Features:

- Clamping the water bottle cage
- For Triathlon bar
- Material: Alloy 6061-T6
- Color: Sandblast black anodize
- Weight: 30g/pcs



MODEL	PRIMARY USES	COLOR	WEIGHT	FEATURES
HB-TR002-100	ROAD BIKE / TRIATHLON	BLACK	54g/set	TRIATHLON BAR BRIDGE
WBC-DX001	ROAD BIKE / TRIATHLON	S.B BLACK / S.B SILVER	30g/set	WATER BOTTLE CAGE ADAPTER

# CYCLO CROSS

## BR-S001

CNC machined. Unique shape and light weight. Spring power is adjustable for more balanced braking.

Product Features:

- Double plate design canti brake system
- Material: Alloy 6061-T6
- Sandblast finished
- Color: black, silver, red
- With FOURIERS logo
- Weight: 205g/set



## BR-S002

CNC machined. Unique shape and light weight. Spring power is adjustable for more balanced braking.

Ultra 6 cross: Recommended for use on front wheel.

Ultra 7 cross: Recommended for use on rear wheel.

Product Features:

- Double plate design canti brake system
- Material: Alloy 6061-T6
- Sandblast finished
- Color: black, silver, red
- With FOURIERS logo
- Weight: 210g/set

MODEL	PRIMARY USES	COLOR	WEIGHT	FEATURES
BR-S001	CYCLO CROSS	BLACK / SILVER RED	205g/set	ARM LENGTH (F) 46mm (R) 46mm
BR-S002	CYCLO CROSS	BLACK / SILVER RED	210g/set	ARM LENGTH (F) 65mm (R) 76mm



## BR-S004

CNC machined. Unique shape and light weight. Spring power is adjustable for more balanced braking.

Made for Robobank Bike team for 2011-2013.

Product Features:

- Double plate design canti brake system
- Material: Alloy 6061-T6
- Sandblast finished
- Color: black, silver, red
- With FURIERS logo
- Weight: 210g/set



## HA-S001 CARBON

Canti Brake cable hanger.  
Carbon spacer can reduce brake noise.

Product Features:

- Material: Carbon 3K
- For Ø28.6 fork tube
- Height: 4mm
- Weight: 29g/set

MODEL	PRIMARY USES	COLOR	WEIGHT	FEATURES
BR-S004	CYCLO CROSS	BLACK / SILVER RED	210g/set	ARM LENGTH (F) 76mm (R) 76mm
HA-S001-100	CYCLO CROSS	3K	29g/pcs	Fits 1-1/8" Fork

# CYCLO CROSS



## BR-E002

CNC machined.  
Stainless steel bolt.  
Angle adjustable with curve washer  
**+5mm offset** to avoid touching the fork  
when releasing wheel.

Product Features:

- Compatible with double plate canti brake system
- Material: Alloy 6066-T6
- Weight: 77g/set



## BR-E003

CNC machined.  
Stainless steel bolt.  
Angle adjustable with curve washer.  
**-5mm offset** to avoid touching the frame  
when releasing wheel.

Product Features:

- Compatible with double plate canti brake system
- Material: Alloy 6066-T6
- Weight: 77g/set



## BR-E004

Forged with CNC machined stainless steel bolt.  
Angle adjustable with curve washer.

Product Features:

- Compatible with double plate canti brake system
- Material: Alloy 6061-T6
- Weight: 77g/set



## BR-E005

Forged with CNC machined stainless steel bolt.  
Angle adjustable with curve washer.

Product Features:

- Compatible with double plate V-brake system
- Material: Alloy 6061-T6
- Weight: 78g/set

MODEL	PRIMARY USES	COLOR	WEIGHT	FEATURES
BR-E002	CYCLO CROSS	BLACK / SILVER / RED	77g/set	Fits CANTI-BRAKE/ Offset +5mm
BR-E003	CYCLO CROSS	BLACK / SILVER / RED	77g/set	Fits CANTI-BRAKE/ Offset -5mm
BR-E004	CYCLO CROSS	BLACK / SILVER / RED	77g/set	Fix CANTI-BRAKE
BR-E005	CYCLO CROSS	BLACK / SILVER / RED	78g/set	Fix CANTI-BRAKE / BRAKE SHOES Length: 72mm



## CR-DX001

High strength aluminum material to get more efficient power. Ultra strong design.

Product Features:

- 5 arm for single speed
- Material: Alloy 7075-T651 full CNC made
- P.C.D: Ø130, Ø144
- **Teeth: 44t ~ 53t**
- Thickness: 3mm
- Color: black, silver, gold anodize



## CR-DX002

High strength aluminum material to get more efficient power. Lightweight design.

Product Features:

- 5 arm for single speed
- Material: Alloy 7075-T651 full CNC made
- P.C.D: Ø130, Ø144
- **Teeth: 44t ~ 53t**
- Thickness: 3mm
- Color: black, silver, gold anodize

MODEL	PRIMARY USES	COLOR	WEIGHT	FEATURES
CR-DX001	TRACK	BLACK / SILVER GOLD		Teeth: 44T~53T / Thickness: 3mm / P.C.D: 130mm or 144mm / 5 arm for single speed
CR-DX002	TRACK	BLACK / SILVER GOLD		Teeth: 44T~53T / Thickness: 3mm / P.C.D: 130mm or 144mm / 5 arm for single speed

# FIXED GEAR

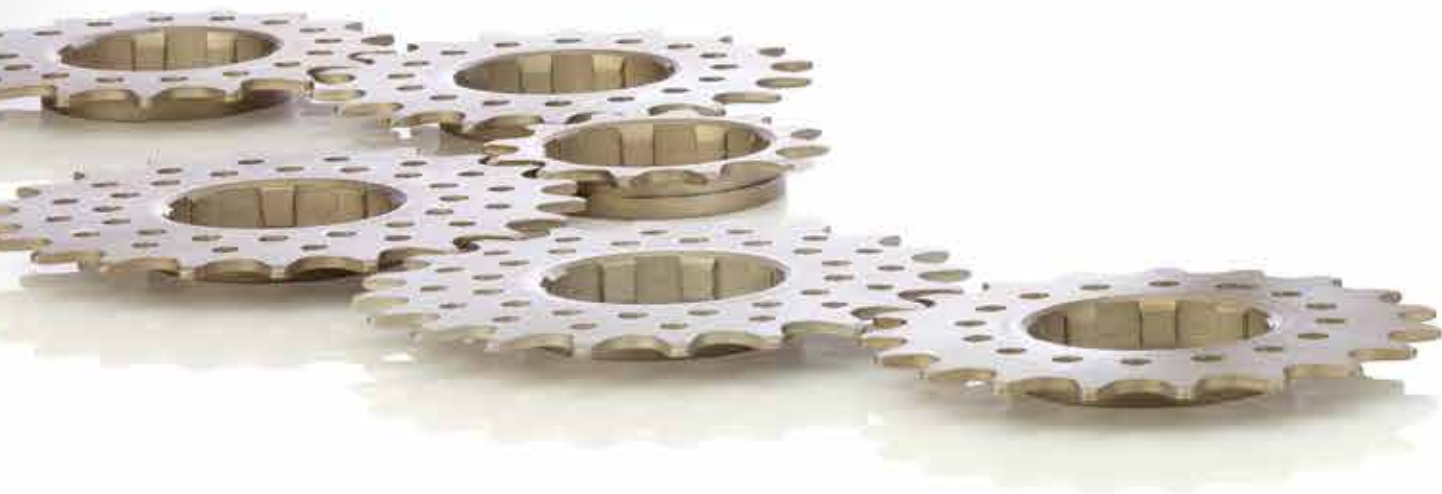

## CR-S001

Design for a cassette hub to convert your bike into a single speed. Cog is made by **harden cold forged Cr-Mo steel (ASM4140)** to make it super strong and to give it a long life. Different sizes are available to cover most riders needs.

### Product Features:

- For cassette HUB
- Material: Cold forged Cr-Mo heat treated steel (ASM4140) N.E.N finished
- With lock ring x 1pcs & 10mm x1, 5mm x2, 3mm x3 Spacer
- Teeth: 12t, 16t ~ 23t



MODEL	PRIMARY USES	COLOR	WEIGHT	FEATURES
CR-S001-120	CASSETTE HUB	ELECTROLESS NICKEL		12t COG+Spacer 10mmx1+5mmx2+3mmx3+Lockring
CR-S001-160	CASSETTE HUB	ELECTROLESS NICKEL		16t COG+Spacer 10mmx1+5mmx2+3mmx3+Lockring
CR-S001-170	CASSETTE HUB	ELECTROLESS NICKEL		17t COG+Spacer 10mmx1+5mmx2+3mmx3+Lockring
CR-S001-180	CASSETTE HUB	ELECTROLESS NICKEL		18t COG+Spacer 10mmx1+5mmx2+3mmx4+Lockring
CR-S001-190	CASSETTE HUB	ELECTROLESS NICKEL		19t COG+Spacer 10mmx1+5mmx2+3mmx4+Lockring
CR-S001-200	CASSETTE HUB	ELECTROLESS NICKEL		20t COG+Spacer 10mmx1+5mmx2+3mmx5+Lockring
CR-S001-210	CASSETTE HUB	ELECTROLESS NICKEL		21t COG+Spacer 10mmx1+5mmx2+3mmx5+Lockring
CR-S001-220	CASSETTE HUB	ELECTROLESS NICKEL		22t COG+Spacer 10mmx1+5mmx2+3mmx6+Lockring
CR-S001-230	CASSETTE HUB	ELECTROLESS NICKEL		23t COG+Spacer 10mmx1+5mmx2+3mmx6+Lockring



## CR-S002

Design to mount onto a 6 bolt disc-hub. This converts your bike into a fixed gear using the special adapter to fix on SHIMANO cassette style hubs. The adapter is made from a lightweight alloy 6061-T6 disc. The cog is made from **hardened cold forged Cr-Mo steel (ASM4140)** to make it super strong and to give it a long life. Comes with 6 stainless bolts.

Product Features:

- Material: cold forged Cr-Mo heat treated steel (ASM4140) and Alloy 6061-T6 for the adapter
- Teeth: 16t ~ 23t
- Color: N.E.N finished cog / red anodize adapter
- Use for disc HUB 6 hole and cassette HUB
- With lock ring x 1pcs & 10mm x1, 5mm x2, 3mm x3 Spacer



## CR-S003

Designed to mount into your hub's 6 bolt disc brake mount to convert your bike into a fixed gear bike. Cog is made from **hardened cold forged Cr-Mo steel (ASM4140)** to make it super strong and to give it a long life. Comes with 6 stainless bolts.

Product Features:

- Material: cold forged Cr-Mo heat treated steel (ASM4140)
- Teeth: 16t ~ 23t
- Color: N.E.N finished for cog
- Use for disc HUB 6 hole



MODEL	PRIMARY USES	COLOR	WEIGHT	FEATURES
CR-S002	CASSETTE HUB	ELECTROLESS NICKEL	56g~103g	16t~23t COG + RED alloy adapter + 6pcs bolt
CR-S003	DISC 6 HOLE	ELECTROLESS NICKEL	35g/set~82g/set	16t~23t COG + 6pcs bolt



# FIXED GEAR



## CR-S004-1.8 CR-S004-3

Designed to mount on single fixed bike hubs. Super strong material from **cold forged Cr-Mo steel (ASM4140)** with special heat treatment. We also have 5 colors for you to choose from. A special washer to put on your hub before you install the cog is also provided to help protect your hub's body.

### Product Features:

- Material: cold forged Cr-Mo heat treated steel.
- For chain: 3/32 (1.8mm) and 1/8 (3mm)
- Teeth: 12t~23t
- Color: ELECTROLESS NICKEL, ED blue, ED orange, ED purple, ED green, ED pink
- With lockring & stainless steel washer



Orange Green Pink Purple Blue



Stainless steel washer

MODEL	PRIMARY USES	COLOR	WEIGHT	FEATURES
CR-S004	FIX GEAR HUB	ELECTROLESS NICKEL / ED PINK / ED BLUE / ED ORANGE / ED VIOLET / ED GREEN	49g/set~133g/set	Teeth Thickness: 3/32" or 1/8" - 12t~23t COG + Lockring



## SCL-S001

Double M5 bolt.

Chamfer edge & oval hole design to protect carbon frames & seatposts.

Rubber cover helps prevent dust and water from getting into the seat tube.



Oval Hole For Carbon

Product Features:

- Bolt Type seatpost clamp CNC Machined
- Polished anodized finish
- Material: Alloy 6066-T6
- Spec: Ø31.8 (Fix Ø27.2 Seatpost) / Ø34.9 (Fix Ø31.6 Seatpost)
- Height: 17.5mm
- Weight: (Ø31.8) 24g / (Ø34.9) 27g
- Color: black, silver, red, gray

## SCL-S002

Double M5 bolt.

Chamfer edge & oval hole design to protect carbon frames.

Product Features:

- Bolt Type seatpost clamp CNC Machined
- Polished anodized finish
- Material: Alloy 6066-T6
- Spec: Ø31.8 or Ø34.9
- Height: 20mm
- Weight: (Ø31.8) 25g / (Ø34.9) 28g
- Color: black, silver, red, gray



Oval Hole For Carbon

## SCL-S003 CARBON

Full UD carbon clamp. Light weight design and a high-end look. Includes a CNC Titanium bolt.

Product Features:

- Material: Carbon / Double Titanium M4 x 18mm bolt
- Spec: Ø31.8, Ø34.9
- Height: 12mm
- Weight: 14g



MODEL	PRIMARY USES	COLOR	WEIGHT	FEATURES
SCL-S001	ALL MODELS	BLACK / SILVER RED / GRAY	24g~27g	Seat tube Ø31.8mm & Seatpost Ø27.2mm or Seat tube Ø34.9mm & Seatpost Ø31.6mm
SCL-S002	ALL MODELS	BLACK / SILVER RED / GRAY	25g~28g	Seat tube Ø31.8mm or Seat tube Ø34.9mm
SCL-S003-300	ALL MODELS	CARBON UD	12g~14g	Seat tube Ø31.8mm or Seat tube Ø34.9mm

# CLAMP



## SCL-E001

Special nut design allows screw to automatically adjust the angle to prevent deformation often caused by too much stress concentration.

Product Features:

- Bolt type seatpost clamp CNC Machined
- Polished anodized or Sandblasted anodized finish
- Material: Alloy 6061-T6
- Spec: Ø31.8, Ø34.9
- Height: 11mm
- Weight: (Ø31.8) 22.5g / (Ø34.9) 23.2g
- Color: black, silver

## SCL-E002

Economic seatclamp / classic design.

Product Features:

- Bolt type seatpost clamp CNC Machined
- Polished anodized or Sandblasted anodized finish
- Material: Alloy 6061-T6
- Spec: Ø31.8, Ø34.9
- Height: 11mm
- Weight: (Ø31.8) 20.2g / (Ø34.9) 22.5g
- Color: black, silver



## SCL-E003

Chamfer edge & oval hole design to protect carbon frames. Classic design.

Product Features:

- Polished anodized
- Material: Alloy 6061-T6
- Spec: Ø31.8, Ø34.9
- Height: 15mm
- Weight: (Ø31.8) 22g / (Ø34.9) 23.5g
- Color: black, silver, red, gray



Oval Hole For Carbon

MODEL	PRIMARY USES	COLOR	WEIGHT	FEATURES
SCL-E001	ALL MODELS	BLACK / SILVER S.B BLACK / S.B SILVER	22.5g~23.2g	Seat tube Ø31.8mm or Seat tube Ø34.9mm
SCL-E002	ALL MODELS	BLACK / SILVER S.B BLACK / S.B SILVER	20.2g~22.5g	Seat tube Ø31.8mm or Seat tube Ø34.9mm
SCL-E003	ALL MODELS	BLACK / SILVER / RED / GRAY	22g~23.5g	Seat tube Ø31.8mm or Seat tube Ø34.9mm

## SCL-QX001

Seat clamp with ultra-lightweight Quick Release.  
 Perfect combination with the ultra light weight QR.  
 Chamfer edge & oval hole design to protect carbon frames.

Product Features:

- QR-Type Seatpost clamp CNC Machined
- Polished anodized finish
- Material: Alloy 6061-T6
- **Washer material: Thermal plastic carbon 40%**
- Spec: Ø31.8 or Ø34.9
- Height: 16mm
- Weight: (Ø31.8) 28g / (Ø34.9) 30.5g
- Color: black, silver, red, gold, gray



## SCL-QX002

Sleek seat clamp with ultra-lightweight quick release lever.  
 Perfect combination with the ultra light weight QR.  
 Chamfer edge & oval hole design to protect carbon frames.

Product Features:

- QR-Type Seatpost clamp CNC Machined
- Polished anodized finish
- Material: Alloy 6061-T6
- **Washer material: Thermal plastic carbon 40%**
- Spec: Ø31.8 or Ø34.9
- Height: 16mm
- Weight: (Ø31.8) 26g / (Ø34.9) 29g
- Color: black, silver, red, gold, gray

MODEL	PRIMARY USES	COLOR	WEIGHT	FEATURES
SCL-QX001	ALL MODELS	BLACK / SILVER / RED / GOLD / GRAY	28g~31g	Seat tube Ø31.8mm or Seat tube Ø34.9mm
SCL-QX002	ALL MODELS	BLACK / SILVER / RED / GOLD / GRAY	26g~29g	Seat tube Ø31.8mm or Seat tube Ø34.9mm

# CLAMP

Turn the nut to lock

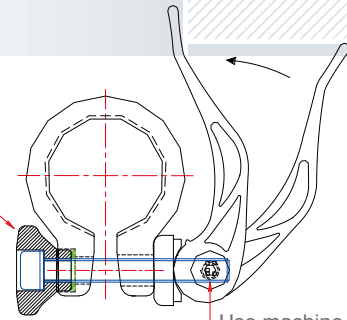

Use machine to break screw, so the screw can't draw out.



## SCL-QE001(P.A.T)



This screw can't be disassembled as it's being made with a special procedure before assembling, to reduce the probability of having the things been stolen.

Product Features:

- QR & Bolt Type seatpost clamp CNC Machined
- Seatclamp: Sandblast anodize
- Material: Alloy 6061-T6
- Spec: Ø31.8 or Ø34.9
- Weight: (Ø31.8) 110g/set / (Ø34.9) 113g/set
- Clamp color: black, silver

Seat tube Ø31.8mm or  
Seat tube Ø34.9mm

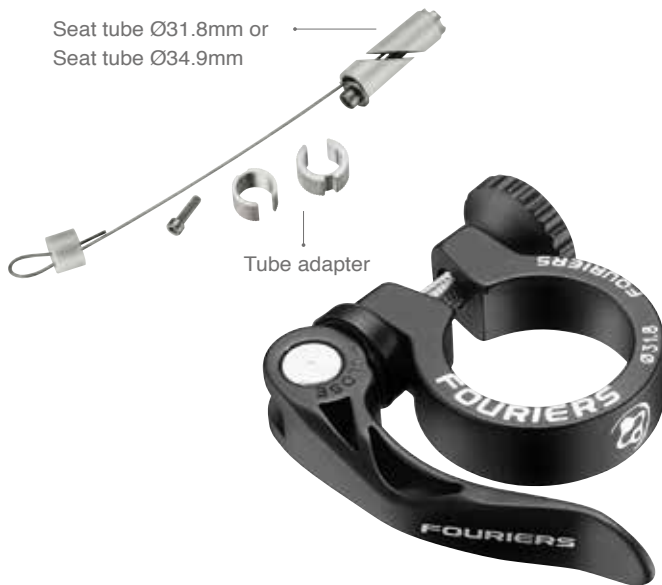

## SCL-QE001-S(P.A.T)



This screw can't be disassembled as it's being made with a special procedure before assembling, to reduce the probability of having the things been stolen.

Product Features:

- QR & Bolt Type seatpost clamp CNC Machined
- Safety steel cable wire
- Seatclamp: Sandblast anodize
- Material: Alloy 6061-T6
- Spec: Ø31.8 or Ø34.9
- Weight: (Ø31.8) 110g/set / (Ø34.9) 113g/set
- Clamp color: black, silver

MODEL	PRIMARY USES	COLOR	WEIGHT	FEATURES
SCL-QE001	ALL MODELS	S.B BLACK S.B SILVER	56g/set-59g/set	Seat tube Ø31.8mm or Seat tube Ø34.9mm
SCL-QE001-S311	ALL MODELS	S.B BLACK	110g/set	Seat tube Ø31.8mm / With anti-theft system
SCL-QE001-S312	ALL MODELS	S.B SILVER	110g/set	Seat tube Ø31.8mm / With anti-theft system
SCL-QE001-S411	ALL MODELS	S.B BLACK	113g/set	Seat tube Ø34.9mm / With anti-theft system
SCL-QE001-S412	ALL MODELS	S.B SILVER	113g/set	Seat tube Ø34.9mm / With anti-theft system

Do you worry about the seatpost on your bike being stolen? Our seatpost retention system along with our special seat clamp, SCL-QE001-S, will help deter would-be thieves from stealing your seatpost and clamp.

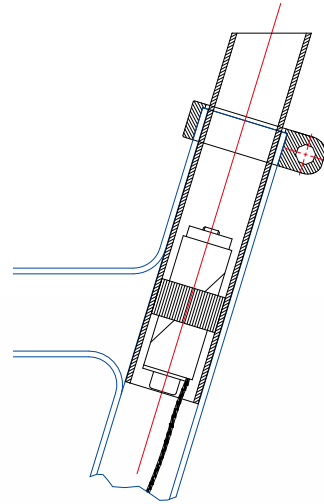

Put the security installation into seatpost and press the screw to fit it at end of the post properly.



To change the attached longer screw instead of the original bottle cage screw and then try to pull the seatpost to make sure the security installation fit well can't be pulled out from the seatpost. After that, to adjust the seatpost insert length and then lock the seat clamp.

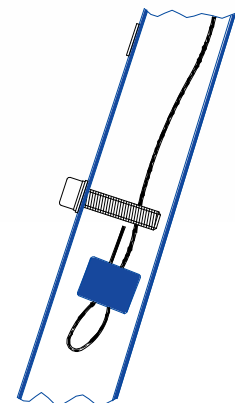



## SR-S003

**Transparent classic Nylon spacer**, Anti solvent unique raw material from Swiss (E.M.S). Different from the normal PC material, our nylon stays more solvent resistant over time. Available in a wide variety of colors.

### Product Features:

- Diameter ID: Ø28.6 OD:Ø36
- Set of 3 spacers: 5mm x 2pcs, 10mm x 1pcs.
- Material: Transparent NYLON
- Weight: 7.2g/set.
- Color: white, blue, orange, light orange, green, clear, light pink, violet, black, yellow

MODEL	PRIMARY USES	COLOR	WEIGHT	FEATURES
SR-S003-001	ALL MODELS	BLACK	7.2g/set	Fits 1-1/8" FORK / 10mm x 1 + 5mm x 2
SR-S003-006	ALL MODELS	BLUE	7.2g/set	Fits 1-1/8" FORK / 10mm x 1 + 5mm x 2
SR-S003-008	ALL MODELS	ORANGE	7.2g/set	Fits 1-1/8" FORK / 10mm x 1 + 5mm x 2
SR-S003-009	ALL MODELS	VIOLET	7.2g/set	Fits 1-1/8" FORK / 10mm x 1 + 5mm x 2
SR-S003-010	ALL MODELS	GREEN	7.2g/set	Fits 1-1/8" FORK / 10mm x 1 + 5mm x 2
SR-S003-011	ALL MODELS	LIGHT PINK	7.2g/set	Fits 1-1/8" FORK / 10mm x 1 + 5mm x 2
SR-S003-012	ALL MODELS	WHITE	7.2g/set	Fits 1-1/8" FORK / 10mm x 1 + 5mm x 2
SR-S003-013	ALL MODELS	CLEAR	7.2g/set	Fits 1-1/8" FORK / 10mm x 1 + 5mm x 2
SR-S003-014	ALL MODELS	LIGHT ORANGE	7.2g/set	Fits 1-1/8" FORK / 10mm x 1 + 5mm x 2
SR-S003-015	ALL MODELS	YELLOW	7.2g/set	Fits 1-1/8" FORK / 10mm x 1 + 5mm x 2



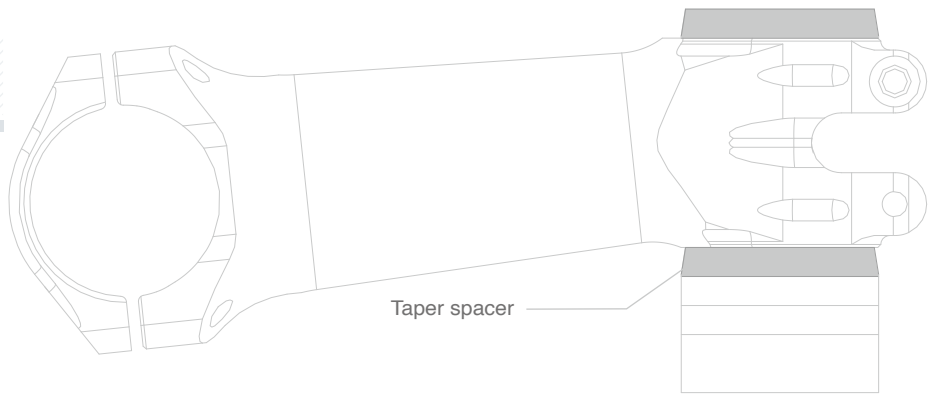

Taper spacer



### SR-S001 CARBON

Classic carbon spacer.

Product Features:

- Diameter ID: Ø28.6 OD: Ø34
- Set of 4 spacers: 3, 5, 10mm, Taper Spacer
- Material: Carbon 3K / Alloy 6061-T6
- Weight: 10.5g/set



### SR-S002 CARBON

Ultra-lightweight carbon spacers.  
Unique design saves up to 38% on weight.

Product Features:

- Diameter ID: Ø28.6 OD: Ø34
- Set of 4 spacers: 3mm, 5mm, 10mm, Taper Spacer
- Material: Carbon 3K / Alloy 6061-T6
- Weight: 8.3g/set



### SR-E001

Classic aluminum spacer.  
High Polishing Anodized finish.

Product Features:

- Diameter ID: Ø28.6 OD: Ø34
- Set of 4 spacers: 3mm, 5mm, 10mm, Taper Spacer
- Material: Alloy 6061-T6
- Weight: 15.5g/set



### SR-E002

Ultra-lightweight Aluminium spacers  
Unique design saves up to 38% on weight.

Product Features:

- Diameter ID: Ø28.6 OD: Ø34
- Set of 4 spacers: 3mm, 5mm, 10mm, Taper Spacer
- Material: Alloy 6061-T6
- Weight: 10.5g/set

MODEL	PRIMARY USES	COLOR	WEIGHT	FEATURES
SR-S001-100	ALL MODELS	3K	10.5g/set	Fits 1-1/8" FORK
SR-S002-100	ALL MODELS	3K	8.3g/set	Fits 1-1/8" FORK
SR-E001	ALL MODELS	BLACK / SILVER / RED / GOLD / GRAY	15.5g/set	Fits 1-1/8" FORK
SR-E002	ALL MODELS	BLACK / SILVER / RED / GOLD / GRAY	10.5g/set	Fits 1-1/8" FORK

# HEADSET



## HA-S008

Integrated headset system.  
Angle contact seal bearing.

Product Features:

- Material: Top cover Alloy 6061-T6
- Spec: Integrated 1-1/8" Upper / 1.5" Bottom  
(UP)  $\varnothing 28.6 \times \varnothing 41.8$  / (DOWN)  $\varnothing 51.8 \times \varnothing 39.5$
- Bearing: (UPPER)  $41.8 \times 45^\circ \times 8$  (LOWER)  $51.8 \times 45^\circ \times 8$
- Weight: 78g/set

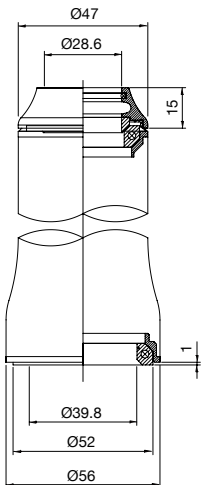

## HA-S009

Integrated headset system.  
Angle contact seal bearing.  
Strong and smooth.

Product Features:

- Material: Top cover Alloy 6061-T6
- Spec: Integrated 1-1/8" Upper / 1-1/8" Bottom  
(UP)  $\varnothing 28.6 \times \varnothing 41.8$  / (DOWN)  $\varnothing 28.6 \times \varnothing 41.8$
- Bearing:  $\varnothing 41.8 \times 45^\circ \times 8$
- Weight: 85g/set

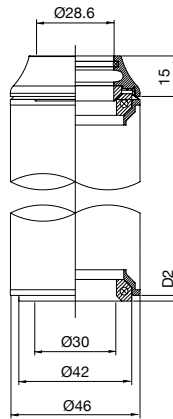

MODEL	PRIMARY USES	COLOR	WEIGHT	FEATURES
HA-S008	ROAD BIKE	S.B BLACK	78g/set	INTEGRATED: 1-1/8" upper / 1.5" bottom
HA-S009	ROAD BIKE	S.B BLACK	85g/set	INTEGRATED: 1-1/8" upper / 1-1/8" bottom

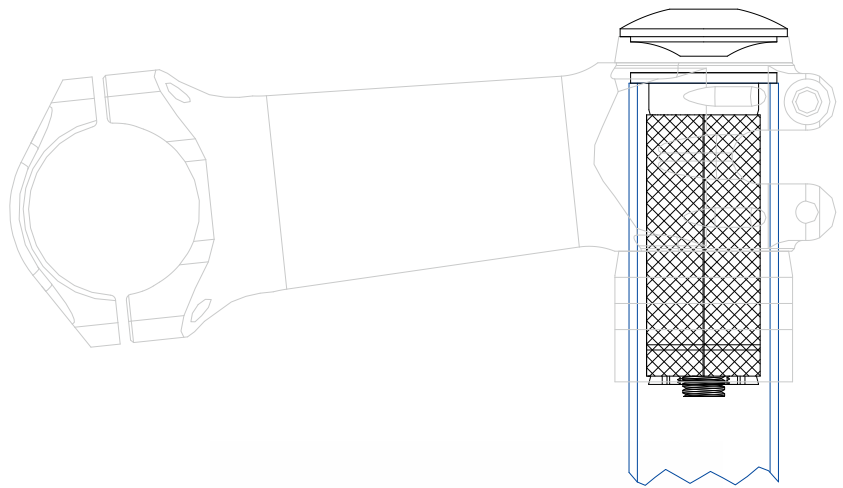

**HA-S003**  
For Giant OD2 System

For Ø31.8 carbon fork inner tube expander.  
Protect carbon fork tube from over tightening.  
Comes with alloy lightweight top cap.

Product Features:

- Material: Alloy 6061-T6 with Alloy top cap.
- For ID Ø27.5 ~ Ø27.7 Fork
- Length: 45mm
- Top Cap Color: black, silver, red, gold, gray
- Weight: 56g/set



**HA-S005**

For Ø28.6 carbon fork inner tube expander.  
Protect carbon fork tube from over tightening.  
Comes with alloy lightweight top cap.

Product Features:

- Material: Alloy 6061-T6 with Alloy top cap.
- For ID Ø22.0 ~ Ø25.0 Fork
- Length: 50mm
- Top Cap Color: black, silver, red, gold, gray
- Weight: 62g/set



**HA-S004**  
For Giant OD2 System

For Ø31.8 alloy or Cr-Mo fork only  
With alloy lightweight top cap.

Product Features:

- Material: Heat treatment star nut with alloy top cap.
- For ID Ø28.8 Fork
- Top Cap Color: black, silver, red, gold, gray
- Weight: 23.5g/set



**HA-S006**

For Ø28.6 alloy or Cr-Mo fork only  
With alloy lightweight top cap.

Product Features:

- Material: Heat treatment star nut with alloy top cap.
- For ID Ø25.4 Fork
- Top Cap Color: black, silver, red, gold, gray
- Weight: 24.5g/set

MODEL	PRIMARY USES	COLOR	WEIGHT	FEATURES
HA-S003	Ø31.8 CARBON FORK	BLACK / SILVER RED / GOLD / GRAY	56g/set	Fits 1-1/4" FORK
HA-S005	Ø28.6 CARBON FORK	BLACK / SILVER RED / GOLD / GRAY	62g/set	Fits 1-1/8" FORK
HA-S004	FOR ALLOY or CR-MO STEEL FORK	BLACK / SILVER RED / GOLD / GRAY	23.5g/set	Fits 1-1/4" FORK / With Star nut
HA-S006	FOR ALLOY or CR-MO STEEL FORK	BLACK / SILVER RED / GOLD / GRAY	24.5g/set	Fits 1-1/8" FORK / With Star nut

# TOP CAP

## TC-DX001

New light weight colored top caps is a great way to update your bike. Made from alloy and full CNC cut smooth surfaces for a high quality finish.

Product Features:

- Material: Alloy 6061-T6
- Spec: Fit on 1-1/8 fork
- Color: black, silver, red, gold, gray, blue, apple green, orange, purple, green
- With FOURIERS logo
- Weight: 9.3g (without star nut)



## TC-DX002

New light weight colored top caps is a great way to update your bike. Made from alloy and full CNC cut smooth surfaces high quality finish.

Product Features:

- Including taper spacer
- Material: Alloy 6061-T6
- Spec: Fit on 1-1/8 fork
- Color: black, silver, red, gold, gray, blue, apple green, orange, purple, green
- With FOURIERS logo
- Weight: 9.8g (without star nut)



## TC-S003 Titanium

Superlight Titanium top cap, CNC machined, also with M6 Titanium bolt.

Product Features:

- Material: Ti-64
- Spec: Fit on 1-1/8 fork
- With Titanium bolt
- With FOURIERS logo
- Weight: 9.5g (without star nut)



MODEL	PRIMARY USES	COLOR	WEIGHT	FEATURES
TC-DX001	ALL MODELS	BLACK / SILVER / RED / GOLD / GRAY / BLUE APPLE GREEN / ORANGE VIOLET / GREEN	9.3g/pcs	Fits 1-1/8" FORK / With stainless bolt
TC-DX002	ALL MODELS	BLACK / SILVER / RED GOLD / GRAY / BLUE APPLE GREEN / ORANGE VIOLET / GREEN	9.8g/pcs	Fits 1-1/8" FORK / With stainless bolt
TC-S003-500	ALL MODELS	TITANIUM	9.5g/pcs	Fits 1-1/8" FORK / With Titanium bolt

## TC-S001

Special stem top cap design to combine with most bottle caps you can buy in the market. It is a super cool design to have your favorite beverage on your bike. Simple to clip on.

Product Features:

- Material: Alloy 6061-T6 CNC finished.
- Spec: Fit on 1-1/8 fork
- With FOURIERS logo
- Weight: 23g (without star nut)
- Color: black, silver



## TC-S002 CARBON

Made of full carbon. Light weight design stem top cap, with stainless main bolt. The only choice to make your bike look like a pros.

Product Features:

- Material: 100% Carbon with stainless bolt
- Spec: Fit on 1-1/8 fork
- Finish: 3K or UD
- with Stainless bolt
- Weight: 14g (without star nut)



## TC-E001

Economic top cap / classic design.

Product Features:

- Material: Alloy 6061-T6
- Spec: Fit on 1-1/8 fork
- Color: black, silver, red, gold, gray, blue, apple green, orange, purple, green
- With FOURIERS logo
- Weight: 14.5g (without star nut)



MODEL	PRIMARY USES	COLOR	WEIGHT	FEATURES
TC-S001	ALL MODELS	BLACK / SILVER	23g/pcs	Fits 1-1/8" FORK / With stainless bolt
TC-S002	ALL MODELS	CARBON 3K / UD	14g/pcs	Fits 1-1/8" FORK / With stainless bolt
TC-E001	ALL MODELS	BLACK / SILVER / RED GOLD / GRAY / BLUE APPLE GREEN / ORANGE VIOLET / GREEN	14.5g/pcs	Fits 1-1/8" FORK / With stainless bolt

# TOP CAP



## TC-S004

New lightweight colored top caps is a great way to upgrade your bike. Make of alloy, full CNC cut, smooth surface high quality finish.

Product Features:

- Material: AL6061-T6 CNC made
- Size: 1-1/8"
- Weight: 15g (with bolt)
- Color: Black anodize



## TC-S005

New lightweight colored top caps is a great way to upgrade your bike. Make of alloy, full CNC cut, smooth surface high quality finish.

Product Features:

- Material: AL6061-T6 CNC made
- Size: 1-1/8"
- Weight: 15g (with bolt)
- Color: Red anodize



## TC-S006

New lightweight colored top caps is a great way to upgrade your bike. Make of alloy, full CNC cut, smooth surface high quality finish.

Product Features:

- Material: AL6061-T6 CNC made
- Size: 1-1/8"
- Weight: 15g (with bolt)
- Color: Red anodize



## TC-S007

New lightweight colored top caps is a great way to upgrade your bike. Make of alloy, full CNC cut, smooth surface high quality finish.

Product Features:

- Material: AL6061-T6 CNC made
- Size: 1-1/8"
- Weight: 15.5g (with bolt)
- Color: Black anodize

MODEL	PRIMARY USES	COLOR	WEIGHT	FEATURES
TC-S004	ALL MODELS	BLACK	15.0g/set	Fits 1-1/8" FORK / With stainless bolt
TC-S005	ALL MODELS	RED	15.0g/set	Fits 1-1/8" FORK / With stainless bolt
TC-S006	ALL MODELS	RED	15.0g/set	Fits 1-1/8" FORK / With stainless bolt
TC-S007	ALL MODELS	BLACK	15.5g/set	Fits 1-1/8" FORK / With stainless bolt





## AC-S002 CARBON

Adapter for stem bar bores. 3 sizes available. Using carbon fiber material's natural properties, it can significantly reduce vibrations when riding.

### Product Features:

- Material: Carbon UD
- Spec: OD Ø35mm to ID Ø31.8mm,  
OD Ø31.8mm to ID Ø26mm,  
OD Ø31.8mm to ID Ø25.4mm
- Width: 60mm

## AC-S001 CARBON

Adapter for stem fork tube Ø31.8mm change to Ø28.6mm.

### Product Features:

- Stem fork tube adapter
- Material: Carbon UD
- Spec: OD Ø31.8mm to ID Ø28.6mm
- Length: 38mm, 48mm, 58mm



MODEL	PRIMARY USES	COLOR	WEIGHT	FEATURES
AC-S002-100	ALL MODELS	UD	14.0g/pcs~24.0g/set	ID: Ø35mm to Ø31.8mm, Ø31.8mm to Ø26mm, or Ø31.8mm to Ø25.4mm / Width: 60mm
AC-S001	ALL MODELS	UD	10.0g~15.5g	ID: Ø31.8mm to ID: Ø28.6mm / Length: 38mm or 48mm or 58mm



## AC-DX001

Full cnc lightweight pulley / Special design to prevent dust and water from getting into the bearing. It's the best choice to shave some weight from your bike.

### Product Features:

- Material: Alloy 7075-T651 body, Alloy 6061-T6 cap
- Bearing: CR-steel seal bearing
- Teeth: 11T
- Weight: 21g/set
- Color: black, silver, red, gold, gray



## AC-S004

SHIMANO center-lock disc hub adapter.

### Product Features:

- SHIMANO center-lock disc hub adapter.
- Material: Alloy 6061-T6 body and lock ring / Stainless steel washer.
- Weight: 41g/set
- Body color: Sandblast black, Sandblast silver

MODEL	PRIMARY USES	COLOR	WEIGHT	FEATURES
AC-DX001	ROAD BIKE / MTB	BLACK / SILVER RED / GOLD / GRAY	21g/set	Fits SHIMANO 8-,9-,10- speed / CAMPAGNOLO 9-,10- speed
AC-S004	MTB	S.B BLACK / S.B SILVER	41g/set	FOR CENTER LOCK DISC HUBS



## BN-M001

Full CNC chainring bolt.

Product Features:

- Chainring bolt.
- Material: Alloy 7075-T6 full CNC made anodized finish
- Spec: M8 x 0.75
- Width: 7mm
- Tool: 5mm or Torx30
- Weight: 2.0g/pair (7mm)
- Color: black, silver, red, gold, gray, blue, apple green, orange, violet, green
- 1 sets = 5 pair



## BN-M003

Special alloy bolt full CNC machined.

Product Features:

- Water bottle cage bolt.
- Material: Alloy 7075-T6 full CNC made anodized finish
- Spec: M5 x 0.8
- Length: 17mm
- Weight: 1.3g/pcs
- Color: black, silver, red, gold, gray, blue, apple green, orange, violet, green



## BN-M002

Special shape of the screw, which can cover the bottle cage hole on the frame.

Product Features:

- Water bottle cage bolt.
- Material: Alloy 7075-T6 full CNC made anodized finish
- Spec: M5 x 0.8
- Length: 10mm
- Weight: 1.3g/pcs
- Color: black, silver, red, gold, gray, blue, apple green, orange, violet, green

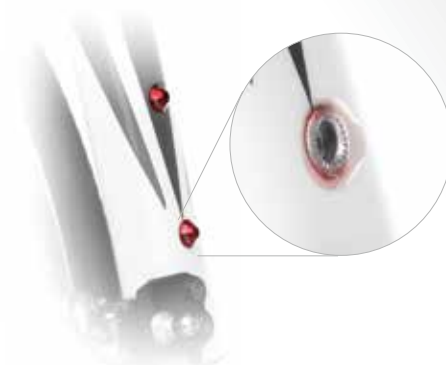

## BN-M004

Special alloy forged bolt.

Product Features:

- Water bottle cage bolt.
- Material: Forged alloy 7075-T6
- Spec: M5 x 0.8
- Length: 17mm
- Weight: 1.3g/pcs
- Color: black, silver, red, gold, gray, blue, apple green, orange, violet, green

MODEL	PRIMARY USES	COLOR	WEIGHT	FEATURES
BN-M001	ALL MODELS	BLACK / SILVER / RED GOLD / GRAY / BLUE APPLE GREEN / ORANGE VIOLET / GREEN	10g/set	M8x0.75 / Length 7mm / Tool hole: 5mm Allen key or Torx 30 / 1set = 5pair
BN-M002	ALL MODELS	BLACK / SILVER / RED GOLD / GRAY / BLUE APPLE GREEN / ORANGE VIOLET / GREEN	2.6g/set	M5x0.8 / Length: 10mm / 4mm Allen key / 1set = 2pcs
BN-M003	ALL MODELS	BLACK / SILVER / RED GOLD / GRAY / BLUE APPLE GREEN / ORANGE VIOLET / GREEN	2.6g/set	M5x0.8 / Length: 10mm / 4mm Allen key / 1set = 2pcs
BN-M004	ALL MODELS	BLACK / SILVER / RED GOLD / GRAY / BLUE APPLE GREEN / ORANGE VIOLET / GREEN	2.5g/set	M5x0.8 / Length: 10mm / 4mm Allen key / 1set = 2pcs

# VALVE EXTENDER



## VL-PE001

Lightweight alloy valve extenders.

Product Features:

- Presta valve extender CNC Machined
- Anodize finished
- Material: Alloy 6061-T6
- With FOURIERS logo
- Spec: 25, 38, 50, 60, 70, 80, 90, 100(mm)
- Color available: black, silver



## VL-PE002

Lightweight alloy valve extenders, with tool.

Product Features:

- Presta valve extender CNC Machined
- Anodize finished
- Material: Alloy 6061-T6
- With FOURIERS logo
- Spec: 20, 30, 40, 50, 60, 70, 80, 90, 100(mm)
- Color available: black, silver

Instructions

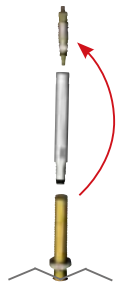

## VL-PE003

Lightweight alloy valve extenders, With tool,  
Only for Vittoria tubular tire.

Product Features:

- Presta valve extender CNC Machined
- Only for Vittoria tubular tire
- Anodize finished
- Material: Alloy 6061-T6
- Spec: 30, 40, 50, 60, 70(mm)
- Color available: black, silver



MODEL	PRIMARY USES	COLOR	WEIGHT	FEATURES
VL-PE001	Presta inner tube	BLACK SILVER	2.2g/set~16g/set	Length: 25mm, 38mm, 50mm, 60mm, 70mm, 80mm, 90mm, 100mm / 1set = 2pcs
VL-PE002-201	Presta inner tube	BLACK SILVER	2.2g/set~12g/set	Length: 20mm, 30mm, 40mm, 50mm, 60mm, 70mm, 80mm, 90mm, 100mm / 1set = 2pcs + Tool x 1pcs
VL-PE003-301	Vittoria inner tube	BLACK SILVER	4.2g/set~10.2g/set	Length: 30mm, 40mm, 50mm, 60mm, 70mm / 1set = 2pcs + Tool x 1pcs



## VL-PE004

Lightweight alloy valve cap with some bling

Product Features:

- Presta valve cap CNC Machined
- Material: Alloy 6061-T6, Anodize finished
- Color:black, silver, red, gold, gray, blue, apple green, orange



## VL-PE005

Disc wheel 90 degree adapter.

Product Features:

- Disc wheel 90 degree adapter
- Fix Presta valve rim
- Material: Alloy 6061-T6 CNC made
- Weight: 9.6g
- Color: black

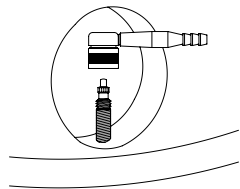

## VL-PE006

Special design to dress up your wheels. Both USA & Presta valve compatible.

Product Features:

- Material: Alloy 6061-T6 CNC made
- Spec: Both USA & Presta valve
- 1 set = 2pcs
- Weight: 7.0g/set
- Color: black, silver, red, gold, gray, blue, apple green, orange

MODEL	PRIMARY USES	COLOR	WEIGHT	FEATURES
VL-PE004	Presta inner tube	BLACK / SILVER / RED GOLD / GRAY / BLUE APPLE GREEN / ORANGE	2.9g/set	Presta 12# x 24 / 1set = 2pcs
VL-PE005	DISC inner tube	BLACK	9.6g/pcs	For Presta valve
VL-PE006	Presta inner tube	BLACK / SILVER / RED GOLD / GRAY / BLUE APPLE GREEN / ORANGE	7.0g/set	Presta 12# x 24 / 1set = 2pcs

# VALVE CAP

## VL-US003



Special designed lightweight valve adapter.  
Switch presta valve to schrader valve.

Product Features:

- Material: Alloy 6061-T6 CNC made
- Spec: Presta change to USA valve
- 1 set = 2pcs
- Weight: 2.3g/set
- Color: black, silver, red, gold, gray.

## VL-US001



Great and inexpensive way to dress up your wheels.

Product Features:

- Material: Alloy 6061-T6 CNC made
- Spec: USA valve
- 1 set = 2pcs
- Weight: 13.0g/set
- Color: black, silver, red, gold, gray.

## VL-US002



Great and inexpensive way to dress up your wheels.

Product Features:

- Material: Alloy 6061-T6 CNC made
- Spec: USA valve
- 1 set = 2pcs
- Weight: 18.7g/set
- Color: black, silver, red, gold, gray

MODEL	PRIMARY USES	COLOR	WEIGHT	FEATURES
VL-US003-001	USA inner tube	BLACK	2.3g/set	Presta change to USA valve
VL-US003-002	USA inner tube	SILVER	2.3g/set	Presta change to USA valve
VL-US003-003	USA inner tube	RED	2.3g/set	Presta change to USA valve
VL-US003-004	USA inner tube	GOLD	2.3g/set	Presta change to USA valve
VL-US003-005	USA inner tube	GRAY	2.3g/set	Presta change to USA valve
VL-US001-001	USA inner tube	BLACK	13.0g/set	For USA valve
VL-US001-002	USA inner tube	SILVER	13.0g/set	For USA valve
VL-US001-003	USA inner tube	RED	13.0g/set	For USA valve
VL-US001-004	USA inner tube	GOLD	13.0g/set	For USA valve
VL-US001-005	USA inner tube	GRAY	13.0g/set	For USA valve
VL-US002-001	USA inner tube	BLACK	18.7g/set	For USA valve
VL-US002-002	USA inner tube	SILVER	18.7g/set	For USA valve
VL-US002-003	USA inner tube	RED	18.7g/set	For USA valve
VL-US002-004	USA inner tube	GOLD	18.7g/set	For USA valve
VL-US002-005	USA inner tube	GRAY	18.7g/set	For USA valve



## TL-S001

Soon to be your favorite tool. Special heat-treated process to prolong the life of the tool.

### Product Features:

- Material: Heat treatment steel 6150 tool / Nylon body
- Spec: 4mm, 5mm, 6mm
- Length: 65mm, 80mm
- Color: Body- black, blue, red, apple green, gray  
Ring- yellow 6mm, orange 5mm, purple 4mm
- Head type: Ball or Hex wrench



MODEL	PRIMARY USES	COLOR	WEIGHT	FEATURES
TL-S001-651	HEX WRENCH	BLACK	62.5g/pcs	4mm , 5mm , 6mm Allen key / Length: 65mm / Hex wrench
TL-S001-653	HEX WRENCH	RED	62.5g/pcs	4mm , 5mm , 6mm Allen key / Length: 65mm / Hex wrench
TL-S001-655	HEX WRENCH	GRAY	62.5g/pcs	4mm , 5mm , 6mm Allen key / Length: 65mm / Hex wrench
TL-S001-656	HEX WRENCH	BLUE	62.5g/pcs	4mm , 5mm , 6mm Allen key / Length: 65mm / Hex wrench
TL-S001-657	HEX WRENCH	APPLE GREEN	62.5g/pcs	4mm , 5mm , 6mm Allen key / Length: 65mm / Hex wrench
TL-S001-6511	HEX WRENCH	BLACK	62.0g/pcs	4mm , 5mm , 6mm Allen key / Length: 65mm / Balldriver
TL-S001-6513	HEX WRENCH	RED	62.0g/pcs	4mm , 5mm , 6mm Allen key / Length: 65mm / Balldriver
TL-S001-6515	HEX WRENCH	GRAY	62.0g/pcs	4mm , 5mm , 6mm Allen key / Length: 65mm / Balldriver
TL-S001-6516	HEX WRENCH	BLUE	62.0g/pcs	4mm , 5mm , 6mm Allen key / Length: 65mm / Balldriver
TL-S001-6517	HEX WRENCH	APPLE GREEN	62.0g/pcs	4mm , 5mm , 6mm Allen key / Length: 65mm / Balldriver
TL-S001-801	HEX WRENCH	BLACK	69.5g/pcs	4mm , 5mm , 6mm Allen key / Length: 80mm / Hex wrench
TL-S001-803	HEX WRENCH	RED	69.5g/pcs	4mm , 5mm , 6mm Allen key / Length: 80mm / Hex wrench
TL-S001-805	HEX WRENCH	GRAY	69.5g/pcs	4mm , 5mm , 6mm Allen key / Length: 80mm / Hex wrench
TL-S001-806	HEX WRENCH	BLUE	69.5g/pcs	4mm , 5mm , 6mm Allen key / Length: 80mm / Hex wrench
TL-S001-807	HEX WRENCH	APPLE GREEN	69.5g/pcs	4mm , 5mm , 6mm Allen key / Length: 80mm / Hex wrench
TL-S001-8011	HEX WRENCH	BLACK	69.0g/pcs	4mm , 5mm , 6mm Allen key / Length: 80mm / Balldriver
TL-S001-8013	HEX WRENCH	RED	69.0g/pcs	4mm , 5mm , 6mm Allen key / Length: 80mm / Balldriver
TL-S001-8015	HEX WRENCH	GRAY	69.0g/pcs	4mm , 5mm , 6mm Allen key / Length: 80mm / Balldriver
TL-S001-8016	HEX WRENCH	BLUE	69.0g/pcs	4mm , 5mm , 6mm Allen key / Length: 80mm / Balldriver
TL-S001-8017	HEX WRENCH	APPLE GREEN	69.0g/pcs	4mm , 5mm , 6mm Allen key / Length: 80mm / Balldriver

# PROTECTOR

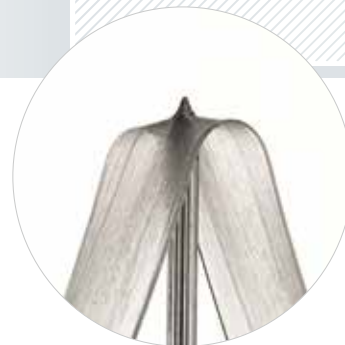

## AC-S005-002

Roads and trails are unpredictable, so protecting your investment is an important decision; This frame protector affixes to the chainstay and protects the frame from chain slap.

Product Features:

- Anti-puncture frame protector
- Material: Polyurethane (PU)
- One pcs has two stickers.
- Weight: 8g



## AC-S005-012

Roads and trails are unpredictable, so protecting your investment is an important decision; These frame protectors affix to your frame to help protect it from many external forces.

Product Features:

- Anti-puncture frame protector
- Material: Polyurethane (PU)
- One pcs has twelve stickers.
- Weight: 15g

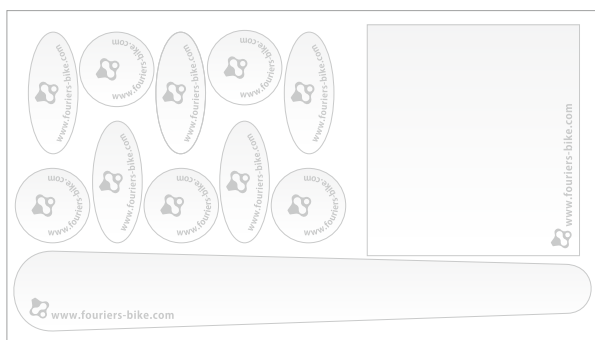

## AC-S005-100

Roads and trails are unpredictable, so protecting your investment is an important decision; Customize the protector into your desired shape, size, and easily stick it to the site needing protection.

Product Features:

- Anti-puncture frame protector
- Material: Polyurethane (PU)
- Spec: (W) 100mm x (L) 1500mm
- Weight: 110.5g



MODEL	PRIMARY USES	COLOR	WEIGHT	FEATURES
AC-S005-002	ALL MODELS	Clean	8g/set	Anti-puncture frame protector / One pcs has two stickers
AC-S005-012	ALL MODELS	Clean	15g/set	Anti-puncture frame protector / One pcs has twelve stickers
AC-S005-100	ALL MODELS	Clean	110.5g/set	Anti-puncture frame protector(W) 100mm x (L) 1500mm

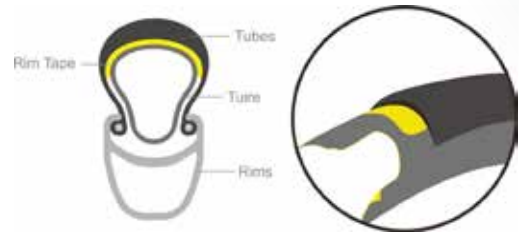

## AC-S006-001

Besides tires and tubes, rim tape is the third most important factor for flat protection. The rim tape effectively protects the tubes against damage. For 700C wheel sizes.

Product Features:

- Puncture protection tape
- For ROAD BIKE (700C)
- Material: Polyurethane (PU)
- Spec: (W) 20mm x (L) 2090mm
- Weight: 37.5g



## AC-S006-129

Besides tires and tubes, rim tape is the third most important factor for flat protection. The rim tape effectively protects the tube against damage. For MTB.

Product Features:

- Puncture protection tape
- For MTB
- Material: Polyurethane (PU)
- Spec: (W) 31mm x (L) 2350mm
- Weight: 71.5g



MODEL	PRIMARY USES	COLOR	WEIGHT	FEATURES
AC-S006-001	ROAD BIKE	Clean	37.5g/set	Puncture protection tape / (W) 20mm x (L) 2090mm
AC-S006-129	MTB	Clean	71.5g/set	Puncture protection tape / (W) 31mm x (L) 2350mm

# FOURIERS PACKAGE







[www.fouriers-bike.com](http://www.fouriers-bike.com)

